

# User manual

## K-BUS<sup>®</sup> KNX Gateway for Tuya ZigBee\_V1.6 BTMO-TY/00.1(2) BTMO-TY/00.3(4)



**KNX/EIB Home and Building Control System**

# Attentions

1. Please keep devices away from strong magnetic field, high temperature, wet environment;

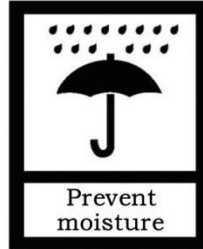
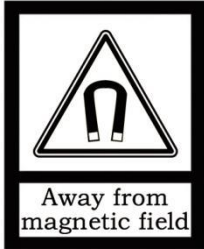

2. Do not fall the device to the ground or make them get hard impact;



3. Do not use wet cloth or volatile reagent to wipe the device;



4. Do not disassemble the devices.

# Contents

Chapter 1 Summary	6
Chapter 2 Technical Data	7
Chapter 3 Dimension and Structural Diagram	8
3.1 Dimension Diagram	8
3.2 Structural Diagram	8
Chapter 4 Project Design and Programming	9
Chapter 5 Parameter setting description in the ETS	11
5.1. Parameter window “General”	11
5.1.1. Parameter window “General setting”	11
5.1.2. Parameter window “IP setting”	12
5.2. Parameter window “KNX Channel ”	13
5.2.1. Parameter window “General setting”	13
5.2.2. Parameter window “KNX Channel setting”	14
5.2.3. Parameter window “Channel x”(x=1~150)	15
5.2.1.1. Parameter of basic function	16
5.2.1.2. Parameter of air condition	20
5.2.1.3. Parameter of room temperature unit	23
5.2.1.4. Parameter of ventilation system	26
5.2.1.5. Parameter of audio control	29
5.2.1.6. Parameter of sensor function	30
5.2.1.7. Parameter of current metering function	33
5.2.1.8. Parameter of energy metering function	33
5.3. Parameter window “Zigbee Channel”	35
5.3.1. Parameter window “Zigbee Channel setting”	35
5.3.2. Parameter window “Channel x” (x=1~32)	35
5.4. Parameter window “Room temperature controller”	39
5.4.1. Parameter window “RTC Channel setting”	39
5.4.2. Parameter window “RTC x”(x=1~10)	39
5.4.1.1. Parameter window “Setpoint”	45
5.4.1.2. Parameter window “Heating/Cooling control”	47
5.4.1.3. Parameter window “Fan”	53
5.5. Parameter window “Ventilation controller”	57
5.5.1. Parameter window “Control setting”	57
5.6. Parameter window “Logic”	64
5.6.1. Parameter window “AND/OR/XOR”	65
5.6.2. Parameter window “Gate forwarding”	67
5.6.3. Parameter window “Threshold comparator”	68
5.6.4. Parameter window “Format convert”	70
5.6.5. Parameter window “Gate function”	71
5.6.6. Parameter window “Delay function”	73

5.6.7. Parameter window “Staircase lighting”	73
<b>Chapter 6 Description of Communication Object</b>	<b>75</b>
6.1. “General” Communication Object	75
6.2. “KNX Channel” Communication Object	75
6.2.1. Communication Object of basic function	76
6.2.2. Communication Object of Air condition	83
6.2.3. Communication Object of Room temperature unit	86
6.2.4. Communication Object of Ventilation system	89
6.2.5. Communication Object of Audio control	92
6.2.6. Communication Object of sensor function	94
6.2.7. Communication Object of current/energy metering	97
6.3. “Zigbee Channel” Communication Object	98
6.4. “Room temperature controller” Communication Object	103
6.5. “Ventilation controller” Communication Object	106
6.6. “Logic” Communication Object	107
6.6.1. “AND/OR/XOR” Communication Object	107
6.6.2. “Gate forwarding” Communication Object	107
6.6.3. “Threshold comparator” Communication Object	108
6.6.4. “Format convert” Communication Object	108
6.6.5. “Gate function” Communication Object	111
6.6.6. “Delay function” Communication Object	112
6.6.7. “Staircase lighting” Communication Object	113
<b>Chapter 7 UI Description for Tuya Smart APP</b>	<b>114</b>
7.1. Add device	114
7.2. Switch interface	118
7.3. Switch/Dimming interface	119
7.4. RGB Dimming interface	120
7.5. Curtain control interface	121
7.6. Value sender interface	122
7.7. KNX Scene switch interface	123
7.8. Air condition interface	125
7.9. Room temperature unit interface	126
7.10. Ventilation system interface	127
7.11. Audio control interface	128
7.12. Sensor interface	129
7.13. Current/Energy metering interface	131
7.14. Voice control command	132
<b>Chapter 8 Tuya Zigbee Gateway Management System</b>	<b>140</b>
8.1. Gateway information	140
8.2. ZigBee device list	141
8.3. ZigBee function list	142
8.4. Linking the ZigBee device	143



## Chapter 1 Summary

KNX Gateway for Tuya ZigBee as the interface between KNX system and Tuya ZigBee system, realizing the connection between the Tuya ZigBee ecosystem and the KNX system. Based on the gateway, it can easily control the KNX devices with Tuya APP, and upload status information of KNX devices to Tuya platform, for monitoring and managing the devices conveniently.

This manual provides detailed technical information about the KNX Gateway for Tuya ZigBee, including installation and programming details, and explains how to use it in the practical examples. After setting up KNX Gateway for Tuya ZigBee on the ETS, you can smartly manage the KNX and Zigbee system products, add and use the devices through the supporting mobile APP——Tuya Smart.

KNX Gateway for Tuya ZigBee powered from KNX bus, and need a 12-30V DC auxiliary supply voltage. It is available to assign the physical address and configure the parameters by engineering design tools ETS with .knxprod ( support edition ETS5.7 or higher ).

The functions are summarized as followed:

- As a ZigBee Gateway function, it can connect to Tuya Cloud, and add ZigBee device of Tuya ecosystem to the cloud
- Support uploading KNX devices to Tuya platform for management, to control KNX device and display status
- Support KNX devices functions, including Switch, Dimming, Curtains, Scenes, Color and Color temperature control, Audio control, HVAC control(Room temperature control, Air conditioner and Ventilation system), multiple sensors(Air Quality, Temperature and humidity, Brightness, Gas, I/O signal and etc.), and Current, Energy Metering display
- Logic functions
- Support bidirectional communication between ZigBee and KNX device(only for premium version BTMO-TY/00.3(4))

## Chapter 2 Technical Data

<b>Power Supply</b>	Bus voltage	21-30V DC, via the KNX bus
	Bus current	<4.5mA, 24V <4mA, 30V
	Bus consumption	<120mW
<b>Auxiliary Supply</b>	Voltage	12-30V DC
	Current	<60mA, 24V <50mA, 30V
	Consumption	<1.5W
<b>Connection</b>	KNX	Bus connection terminal(Red/Black)
	Auxiliary Supply	Bus connection terminal(Yellow/White)
	LAN	RJ45 socket for 100 Mbit and 10 Mbit BaseT, IEEE 802.3 networks
	Antenna	Rubber rod antenna or extension antenna (3m)
	Wireless communication	Network without barriers: >100m Network with barriers: >10m ( Across two walls)
<b>Operation and display</b>	Connect button	Long press 5s will disconnect gateway
	Connect status LED	On: connecting; Off: connected Fast flashing: Tuya authorization code is abnormal (Unprogram)
	LAN LED	On: connected; Off: disconnected Flashing: Data communication
	Programming button and LED	Red on: assign physical address Green flashing: running normally
<b>Temperature</b>	Operation	- 5 °C ... 45 °C
	Storage	- 25 °C ... 55 °C
	Transport	- 25 °C ... 70 °C
<b>Environment</b>	Humidity	<93%, except dewing
<b>Design</b>	Standard 35mm DIN rail installation	
<b>Dimension</b>	36 x 90 x 64mm	
<b>Weight</b>	0.15kg	

## Chapter 3 Dimension and Structural Diagram

### 3.1 Dimension Diagram

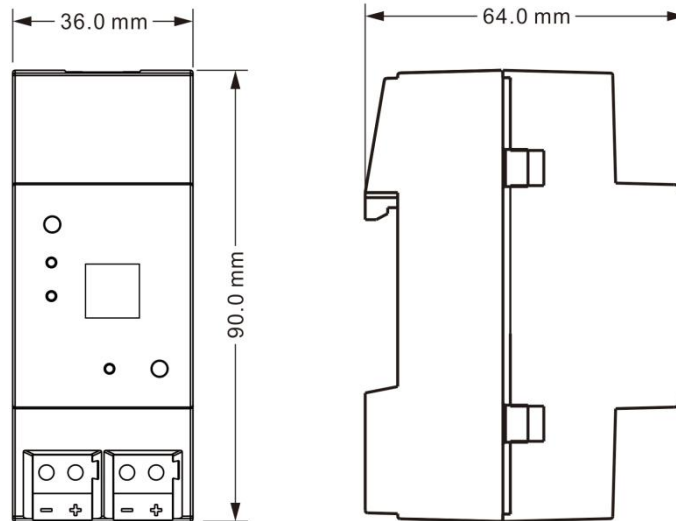

### 3.2 Structural Diagram

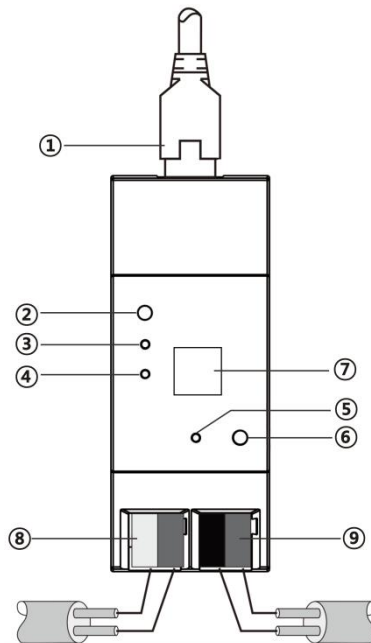

- ① LAN connection
- ② Connect button
- ③ Connect status LED
- ④ LAN LED
- ⑤ Programming LED

- ⑥ Programming button
- ⑦ Antenna interface
- ⑧ Auxiliary supply connection terminal
- ⑨ KNX bus connection



## Chapter 4 Project Design and Programming

Application	Maximum of communication objects	Maximum number of group addresses	Maximum number of associations
<b>KNX Gateway for Tuya ZigBee/1.0</b> <b>KNX Gateway for Tuya ZigBee,Premium/1.0</b>	<b>3933</b>	<b>8000</b>	<b>8000</b>

### General function

General function includes device In operation setting and IP setting.

### KNX channel function

Support to upload the KNX device to the Tuya platform for management, which to control the device and display status. Up to support 150 devices. Each device can be customized its name with the engineering design tools ETS, and has In operation setting to monitor whether the device is online and upload to APP.

Top 100 device channels support the whole functions, including switch, dimming, curtain, scene switch, color and color temperature (RGB, RGBW and color temperature), audio control, HVAC control (Room temperature control, Air conditioner and Ventilation), multiple sensors (Air quality, humidity and temperature, brightness, gas, I/O signal and etc.), and current, energy display.

The latter 50 device channels only support the functions, including switch, dimming, curtain, air quality sensor and energy display.

**Note: Request each device status when the gateway power on.**

### Zigbee channel function (only for premium version BTMO-TY/00.3(4))

Support bidirectional communication between ZigBee and KNX device, for integrating Zigbee devices into KNX system, up to 32 device data points, which can be set with name and MAC address information on the ETS. Use the website (Tuya Zigbee Gateway Management System) to configure and manger the linkage between Zigbee devices and KNX system.

Support to control the following Zigbee devices with the KNX system:

Sensor: Air quality sensor, Temperature and humidity sensor, Brightness sensor, Gas sensor, and I/O signal (Switch, Boolean, Alarm, Occupancy sensor, Window/door sensor);

Zigbee lamp: lamp, dimmable lamp, RGB bulb/strip, color temperature light and RGBCW bulb;

Electric curtain.

### **Room temperature controller**

Up to support 10 room temperature controllers. Mainly used to control the room temperature, Automatically and optimally cooling/heating control according to the room use or the occupants needs.

Support to manual switch to heating/cooling control, optionally three fan speeds and the auto fan speed, 4 operation modes: comfort, standby, economy and protection mode.

The temperature setpoint value supports the relative setting method, and is adjustable range setting. Support 2 points and PI control.

### **Ventilation controller**

Support 1 ventilation controller, and fan speed can be linked to PM2.5/CO2/VOC, optionally output types of 1bit of 1byte.

### **Logic function**

Up to support 8 channels of logic, each channel up to support 8 inputs and 1 logic result.

Logic function support functions, including AND, OR, XOR, Gate forwarding, Threshold comparator, Format convert, Gate function, Delay function and Staircase lighting.

## Chapter 5 Parameter setting description in the ETS

### 5.1. Parameter window “General”

#### 5.1.1. Parameter window “General setting”

Fig.5.1.1 “General setting” Parameter window

#### Parameter “Device ID”

This parameter is for setting the device ID. Options: **0...65535**

#### Parameter “Device name”

This parameter is for setting the device name. Up to input 32 characters.

#### Parameter “Send delay after power on [0..15]s”

This parameter is for setting the delay time to send to bus after the gateway power on. Options: **0..15**

The setting dose not contain the gateway initialization time, and bus telegrams received during delay time will be recorded.

#### Parameter “Send cycle of “In operation” telegram [1..240s, 0 = inactive]”

This parameter is for setting the time interval when this device cycle send telegrams through the bus to indicate this module in normal operation. When set to “0”, the object “in operation” will not send a telegram. If the setting is not “0”, the object “In operation” will send a telegram according to the set period time with logic “1” to the bus. Options: **0...240s, 0= inactive**

As to reduce the bus load as much as possible, the maximum time interval should be selected according to actual needs.

### 5.1.2. Parameter window “IP setting”

Fig.5.1.2 “IP setting” Parameter window

#### Parameter “IP assignment”

This parameter is for setting the assignment of IP address. Options:

**DHCP**

**Fixed**

Fixed: the assignment of IP address is fixed, can be assigned address for device via the parameters as follow.

DHCP: the parameters as follow are not visible when DHCP enabled, and no need to configure.

#### Parameter “IP address (device)”

This parameter is for setting the IP address of device, and the IP address must be unique in the LAN, otherwise causing a conflict between IP.

Enter the address in IPv4 format, for example: 192.168.1.10

Options: **0-255.0-255.0-255.0-255**

#### Parameter “Default Gateway”

This parameter is for setting the default gateway. That is the default gateway of network segment which the device connects to.

Enter the address in IPv4 format, for example: 192.168.1.1

Options: **0-255.0-255.0-255.0-255**

#### Parameter “Subnet Mask”

This parameter is for setting the subnet mask. That is the subnet mask of network segment which the device connects to.

Enter the address in IPv4 format, for example: 255.255.255.0

Options: **0-255.0-255.0-255.0-255**

#### Parameter “DNS server”

This parameter is for setting the DNS server of device.

Use string with IPv4 to input address, for example: 192.168.1.1

Options: **0-255.0-255.0-255.0-255**

## 5.2. Parameter window “KNX Channel ”

### 5.2.1. Parameter window “General setting”

--- KNX Gateway for Tuya ZigBee > KNX Channel > General setting

General	Status object read request after restart	<input checked="" type="checkbox"/>
General setting	Send request delay between status objects	100 ms
IP setting	Device online status request setting for common x	
KNX Channel	Time period request for common 1 [0..255,0=inactive]	0 min
General setting	Time period request for common 2 [0..255,0=inactive]	0 min
KNX Channel setting	Time period request for common 3 [0..255,0=inactive]	0 min
Channel 1-10	Time period request for common 4 [0..255,0=inactive]	0 min
Channel 11-20	Time period request for common 5 [0..255,0=inactive]	0 min
Channel 21-30	Time period request for common 6 [0..255,0=inactive]	0 min
Channel 31-40	Time period request for common 7 [0..255,0=inactive]	0 min
Channel 41-50	Time period request for common 8 [0..255,0=inactive]	0 min
Channel 51-60	Time period request for common 9 [0..255,0=inactive]	0 min
Channel 61-70	Time period request for common 10 [0..255,0=inactive]	0 min
Channel 71-80		
Channel 81-90		

Fig.5.2.1 “General setting” Parameter window

#### Parameter “Status object read request after restart”

This parameter is for setting whether to send read request telegram of status after restart device.

#### Parameter “Send request delay between status objects”

This parameter is visible when previous parameter is enabled. Set the interval time for sending between request telegrams when power on. Options:

**50ms**

**100ms**

**200ms**

#### Device online status request setting for common x

#### Parameter “Time period request for common x [0..255,0=inactive] min”(x=1-10)

This parameter is for setting the read request period to send to query the online status of the common device,

0 is not enable query function. Options: **0..255**

The function is used to query the online status of the KNX device. Requests begin after the gateway power-up send delay time complete.

### 5.2.2. Parameter window “KNX Channel setting”

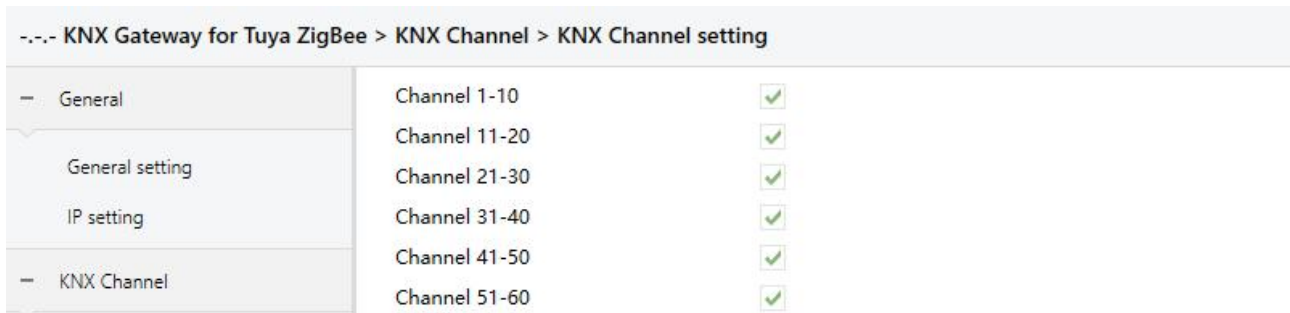

Fig.5.2.2(1) “KNX Channel setting” Parameter window

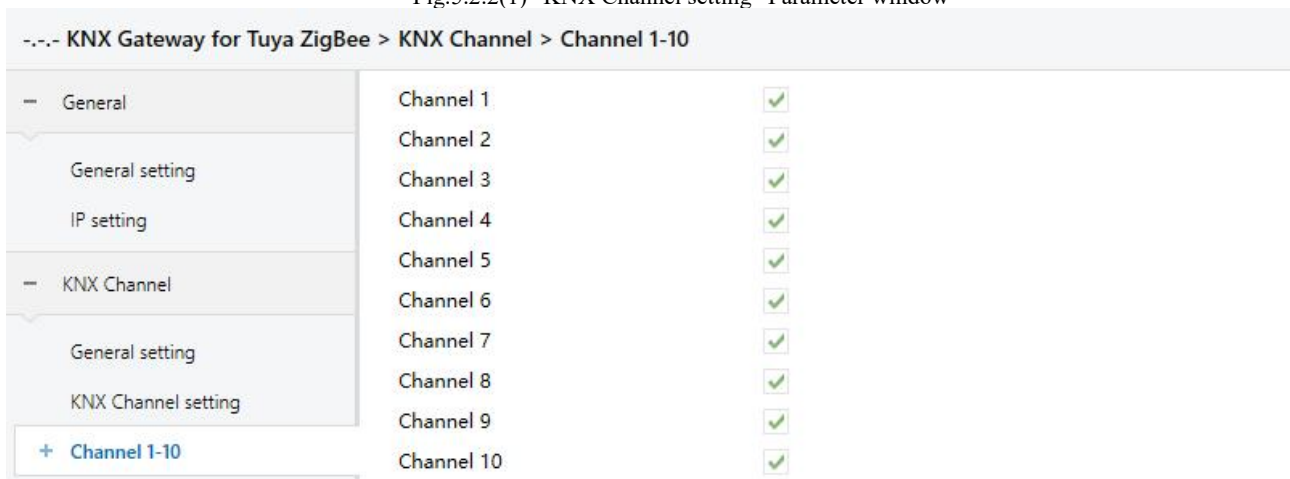

Fig.5.2.2(2) “Channel 1-10” Parameter window

#### Parameter “Channel 1-10/11-20/21-30/...”

This parameter is for setting the enable KNX device. Display 10 KNX channels per page when enabled. Up to support 150 channels.

#### Parameter “Channel 1/2/3/...”

This parameter is for setting the KNX device setting. Display corresponding window when enabled.

### 5.2.3. Parameter window “Channel x”(x=1~150)

Fig.5.2.3 “Channel 1” Parameter window

Parameters as follow is general setting parameters for KNX device type. Later chapters will not be repeated.

#### Parameter “Device type”

This parameter is for setting the device type of KNX channel. Options:

- |   |                                   |
|---|-----------------------------------|
| <b>Switch</b>   | <b>Ventilation system</b>         |
| <b>Switch/Dimming</b>   | <b>Audio control</b>              |
| <b>RGB dimming</b>  | <b>Audio control(with on/off)</b> |
| <b>RGBW dimming</b>   | <b>Air quality sensor</b>         |
| <b>Color temperature</b>  | <b>CO2 sensor</b>                 |
| <b>Curtain step/move</b>  | <b>PM2.5 sensor</b>               |
| <b>Roller blind step/move</b>                                     | <b>VOC sensor</b>                 |
| <b>Curtain position</b>   | <b>Presence sensor</b>            |
| <b>Roller blind position</b>                                      | <b>Motion sensor</b>              |
| <b>Venetian blind position and slat</b>                           | <b>Brightness sensor</b>          |
| <b>Value sender</b>   | <b>I/O signal</b>                 |
| <b>Scene switch</b>   | <b>Current metering</b>           |
| <b>Air conditioner</b>  | <b>Energy metering</b>            |
| <b>Air conditioner(with swing)</b>                                |                                   |
| <b>Room temperature unit</b>                                      |                                   |
| <b>Room temperature unit(with operation mode)</b>                 |                                   |
| <b>Room temperature unit(with operation mode &amp; fan speed)</b> |                                   |

**Note:** Channel 1~100 support all of the above function options, but channel 101~150 only support the functions as follow:

- Switch**
- Switch/Dimming**
- Curtain step/move**
- Roller blind step/move**
- Air quality sensor**
- Energy metering**

Parameter “Description (max 30char.)”

This parameter is for setting the name description for current channel device, up to input 30 characters.

Parameter “Device online status reference by”

This parameter is for setting the reference type sending read request to KNX device, you can select request for individual or common device, and optionally 10 common device requests. Options:

- Common 1**
- ...
- Common 10**
- Individual**
- Always online**

When select “Common ...”, common device request, apply to the device with multiple circuits. For example, multiple channels of gateway may be multiple circuits that control the same KNX device, so each channel can share one request.

When select “Individual”, apply to a device only is controlled by gateway single channel.

When select “Always online”, apply to the KNX device without heartbeat pack, especially scene. That is, once configure the device, it will always online.

Parameter “Time period for request [1..255] min”

This parameter is visible when “Individual” is selected, set the time period for the online status request of single device. Options: **1..255**

**5.2.1.1. Parameter of basic function**

This chapter explains the basic functions parameters of KNX channel, including switch, dimming, curtain, color, color temperature, value sender and KNX scene switch.

--- KNX Gateway for Tuya ZigBee > KNX Channel > Channel 1-10 > Channel 1

+ General	Device type	Switch
- KNX Channel	Description (max 30char.)	
General setting	Device online status reference by	Individual
KNX Channel setting	Time period for request [1..255]	10 min

Parameter setting of “Switch”



--- KNX Gateway for Tuya ZigBee > KNX Channel > Channel 1-10 > Channel 1

+ General	Device type	Switch/Dimming
- KNX Channel	Description (max 30char.)	
General setting	Device online status reference by	Individual
KNX Channel setting	Time period for request [1..255]	10 min
- Channel 1-10	Min. brightness value [0..50]	0 %
	Max. brightness value [51..100]	100 %

Parameter setting of "Switch/Dimming"

--- KNX Gateway for Tuya ZigBee > KNX Channel > Channel 1-10 > Channel 1

+ General	Device type	Curtain step/move
- KNX Channel	Description (max 30char.)	
General setting	Device online status reference by	Individual
KNX Channel setting	Time period for request [1..255]	10 min

Parameter setting of curtain

--- KNX Gateway for Tuya ZigBee > KNX Channel > Channel 1-10 > Channel 1

+ General	Device type	RGB dimming
- KNX Channel	Description (max 30char.)	
General setting	Device online status reference by	Individual
KNX Channel setting	Time period for request [1..255]	10 min
	Object datatype	<input checked="" type="radio"/> 1x3byte <input type="radio"/> 3x1byte

Parameter setting of "RGB dimming"

--- KNX Gateway for Tuya ZigBee > KNX Channel > Channel 1-10 > Channel 1

+ General	Device type	RGBW dimming
- KNX Channel	Description (max 30char.)	
General setting	Device online status reference by	Individual
KNX Channel setting	Time period for request [1..255]	10 min
	Object datatype	<input checked="" type="radio"/> 1x6byte <input type="radio"/> 4x1byte

Parameter setting of "RGBW dimming"

--- KNX Gateway for Tuya ZigBee > KNX Channel > Channel 1-10 > Channel 1

+ General	Device type	Color temperature
- KNX Channel	Description (max 30char.)	
General setting	Device online status reference by	Always online
KNX Channel setting	Min. color temperature [2000..7000]	2700 K
	Max. color temperature [2000..7000]	6500 K

Parameter setting of "Color temperature"

--- KNX Gateway for Tuya ZigBee > KNX Channel > Channel 1-10 > Channel 1

+ General	Device type	Value sender
- KNX Channel	Description (max 30char.)	
General setting	Device online status reference by	Individual
KNX Channel setting	Time period for request [1..255]	10 min
- Channel 1-10	Output object datatype for trigger	1bit[On/Off]
	Output value	<input type="radio"/> OFF <input checked="" type="radio"/> ON

Parameter setting of "Value sender"

--- KNX Gateway for Tuya ZigBee > KNX Channel > Channel 1-10 > Channel 1

+ General	Device type	Scene switch
- KNX Channel	Description (max 30char.)	
General setting	Device online status reference by	Individual
KNX Channel setting	Time period for request [1..255]	10 min
	Trigger scene No. from KNX	1

Parameter setting of "Scene switch"

Fig.5.2.1.1 Parameter setting of basic function

Parameter "Min. brightness value [0..50]%"

Parameter "Max. brightness value [51..100]%"

These two parameters are visible when device type is selected "Switch/Dimming". Set the upper and lower limit threshold value of brightness.

The lower limit threshold value options: **0..50**; the upper limit threshold value options: **51..100**

Parameter "Object datatype"

This parameter is visible when device type is selected "RGB dimming" or "RGBW dimming". Set the object datatype of RGB or RGBW dimming.

Suitable for RGB type:

**1x3byte**

**3x1byte**

Suitable for RGBW type:

**1x6byte**

**4x1byte**

Parameter "Min. color temperature [2000..7000]K"

Parameter "Max. color temperature [2000..7000]K"

These two parameters are visible when device type is selected "Color temperature". Set the upper and lower

limit threshold value of color temperature. Options: **2000..7000**

When the minimum value and maximum value are set incorrect, The selected range is the whole range, for example the minimum value is larger than the maximum value. There is only one value when equal.

#### Parameter "Output object datatype for trigger"

This parameter is visible when device type is selected "Value sender". Set telegram type for sending to KNX bus when trigger calling command on the APP. Options:

**1bit[On/Off]**

**2bit[0..3]**

**1byte[0..100%]**

**1byte[0..255]**

**1byte[scene control]**

**2byte[Float]**

**2byte[0..65535]**

#### Parameter "Output value"

This parameter is visible when device type is selected "Value sender", and corresponding datatype is selected. Set the telegram value for sending to KNX bus when trigger calling command on the APP. Options are according to the datatype:

**OFF ON(1bit) / 0..3(2bit) / 0..100(1byte) / 0..255(1byte) / 1..64(1byte) /**

**-671 088.64..670 760.96(2byte) / 0..65535(2byte)**

#### Parameter "Trigger scene No. from KNX"

This parameter is visible when device type is selected "Scene switch". Set the scene calling command of KNX system to receive. Options:**1..64**

### 5.2.1.2. Parameter of air condition

This chapter explains the air condition function of KNX channel, including the basic and air conditioning control with swing. Parameters as follow are visible when “Air conditioner” or “Air conditioner(with swing)” is selected.

--- KNX Gateway for Tuya ZigBee > KNX Channel > Channel 1-10 > Channel 1

<ul style="list-style-type: none"> <li>+ General</li> <li>- KNX Channel                             <ul style="list-style-type: none"> <li>General setting</li> <li>KNX Channel setting</li> <li>- Channel 1-10                                     <ul style="list-style-type: none"> <li style="background-color: #e0e0e0;">Channel 1</li> <li>Channel 2</li> <li>Channel 3</li> <li>Channel 4</li> <li>Channel 5</li> <li>Channel 6</li> <li>Channel 7</li> <li>Channel 8</li> <li>Channel 9</li> <li>Channel 10</li> </ul> </li> <li>+ Channel 11-20</li> <li>+ Channel 21-30</li> <li>+ Channel 31-40</li> <li>+ Channel 41-50</li> <li>+ Channel 51-60</li> <li>+ Channel 61-70</li> <li>+ Channel 71-80</li> <li>+ Channel 81-90</li> </ul> </li> </ul>	<div style="border-bottom: 1px solid #ccc; padding-bottom: 5px;"> <p>Device type <span style="float: right;">Air conditioner ▼</span></p> </div> <p>Description (max 30char.) <input style="width: 90%;" type="text"/></p> <p>Device online status reference by <span style="float: right;">Individual ▼</span></p> <p>Time period for request [1..255] <input style="width: 60%;" type="text" value="10"/> min</p> <p>Time period for request room temperature sensor [0..255] <input style="width: 60%;" type="text" value="10"/> min</p> <p>Min. setpoint temperature [16..32] <span style="float: right;">16 ▼ °C</span></p> <p>Max. setpoint temperature [16..32] <span style="float: right;">32 ▼ °C</span></p> <p><b>Control mode setting</b></p> <p>Auto mode <span style="float: right;"><input type="radio"/> Disable <input checked="" type="radio"/> Enable</span></p> <p>Output value for auto [0..255] <input style="width: 60%;" type="text" value="0"/></p> <p>Status value for auto [0..255] <input style="width: 60%;" type="text" value="0"/></p> <p>Heating mode <span style="float: right;"><input type="radio"/> Disable <input checked="" type="radio"/> Enable</span></p> <p>Output value for heating [0..255] <input style="width: 60%;" type="text" value="1"/></p> <p>Status value for heating [0..255] <input style="width: 60%;" type="text" value="1"/></p> <p>Cooling mode <span style="float: right;"><input type="radio"/> Disable <input checked="" type="radio"/> Enable</span></p> <p>Output value for cooling [0..255] <input style="width: 60%;" type="text" value="3"/></p> <p>Status value for cooling [0..255] <input style="width: 60%;" type="text" value="3"/></p> <p>Fan mode <span style="float: right;"><input type="radio"/> Disable <input checked="" type="radio"/> Enable</span></p> <p>Output value for fan [0..255] <input style="width: 60%;" type="text" value="9"/></p> <p>Status value for fan [0..255] <input style="width: 60%;" type="text" value="9"/></p> <p>Dehumidification mode <span style="float: right;"><input type="radio"/> Disable <input checked="" type="radio"/> Enable</span></p> <p>Output value for dehumidification [0..255] <input style="width: 60%;" type="text" value="14"/></p> <p>Status value for dehumidification [0..255] <input style="width: 60%;" type="text" value="14"/></p>
--	---

Fig.5.2.1.2(1) Parameter setting of air condition function

<ul style="list-style-type: none"> <li>Channel 10</li> <li>+ Channel 11-20</li> <li>+ Channel 21-30</li> <li>+ Channel 31-40</li> <li>+ Channel 41-50</li> <li>+ Channel 51-60</li> <li>+ Channel 61-70</li> <li>+ Channel 71-80</li> <li>+ Channel 81-90</li> <li>+ Channel 91-100</li> <li>+ Channel 101-110</li> </ul>	<p>Object datatype of 1byte fan speed</p> <p><input type="radio"/> Fan stage (DPT_5.100)</p> <p><input checked="" type="radio"/> Percentage (DPT_5.001)</p> <p><b>Output value for fan speed</b></p> <p>Output value for fan speed auto: <input type="text" value="0"/> %</p> <p>Output value for fan speed low: <input type="text" value="33"/> %</p> <p>Output value for fan speed medium: <input type="text" value="67"/> %</p> <p>Output value for fan speed high: <input type="text" value="100"/> %</p> <p><b>Status feedback for fan speed</b></p> <p>Status value for fan speed auto: <input type="text" value="0"/> %</p> <p>Status value for fan speed low: <input type="text" value="33"/> %</p> <p>Status value for fan speed medium: <input type="text" value="67"/> %</p> <p>Status value for fan speed high: <input type="text" value="100"/> %</p>
---	--

Fig.5.2.1.2(2) Parameter setting of air condition function

**Parameter "Time period for request room temperature sensor [0..255]min"**

This parameter is for setting the time period for read request room temperature sensor. Options: **0..255**

Send read request as default when the device voltage recovery.

**Parameter "Min./Max. setpoint temperature [16..32]° C"**

These two parameters are for setting the adjustable range of the setpoint temperature. If the setpoint temperature beyond the limited range, the will output the limited temperature. Options:

**16°C**

**17°C**

...

**32°C**

For setpoint temperature, the Min. value must less than the Max., if not, it can not be modified on ETS.

**Control mode setting**

**Parameter "Auto/Heating/Cooling/Fan/Dehumidification mode"**

Corresponding mode setting is visible when these parameters are enabled.

**Parameter "Output value for auto/heating/cooling/fan/dehumidification [0..255]"**

These parameters are visible when the modes are enabled. Set the output value for switching to each mode.

Options:**0..255**

Parameter "Status value for auto/heating/cooling/fan/dehumidification [0..255]"

These parameters are visible when the modes are enabled. Set the status feedback value of each mode.

Options: **0..255**

Parameter "Object datatype of 1byte fan speed"

This parameter is for setting the object datatype of 1byte fan speed. Options:

**Fan stage (DPT 5.100)**

**Percentage (DPT 5.001)**

### Output value for fan speed

Parameter "Output value for fan speed auto/low/medium/high"

These parameters are for setting the output value for switching to each fan speed, support 4 fan speeds: auto, low, medium, high. Options are according to the object datatype of previous parameter: **0..255/0..100**

### Status feedback for fan speed

Parameter "Status value for fan speed auto/low/medium/high"

These parameters are for setting the status feedback value of each fan speed, support 4 fan speeds: auto, low, medium, high. Options are according to the object datatype of previous parameter: **0..255/0..100**

**Note: the out value and status value must meet the condition  $low < medium < high$ , if not, they can not be configured on ETS, and display red box warning, as shown as follow:**

Output value for Fan speed auto	<input type="text" value="0"/>	%
Output value for Fan speed low	<input style="border: 2px solid red;" type="text" value="68"/>	%
Output value for Fan speed medium	<input type="text" value="67"/>	%
Output value for Fan speed high	<input type="text" value="100"/>	%



### 5.2.1.3. Parameter of room temperature unit

This chapter explains the room temperature unit function of KNX channel, including the basic, control with control mode, and with fan speed. Parameters as follow are visible when “Room temperature unit”, “Room temperature unit(with operation mode)” or “Room temperature unit(with operation mode & fan speed)” is selected.

--- KNX Gateway for Tuya ZigBee > KNX Channel > Channel 1-10 > Channel 1

+ General	Device type	Room temperature unit(with operation mode & fan speed)
- KNX Channel	Description (max 30char.)	
General setting	Device online status reference by	Individual
KNX Channel setting	Time period for request [1..255]	10 min
- Channel 1-10	Time period for request room temperature sensor [0...255]	10 min
Channel 1	Min. setpoint temperature [5..40]	5 °C
Channel 2	Max. setpoint temperature [5..40]	40 °C
Channel 3	Control mode	Heating and Cooling
Channel 4	<b>Fan speed setting</b>	
Channel 5	Object datatype of 1byte fan speed	<input type="radio"/> Fan stage (DPT_5.100) <input checked="" type="radio"/> Percentage (DPT_5.001)
Channel 6	<b>Output value for fan speed</b>	
Channel 7	Output value for fan speed low	33 %
Channel 8	Output value for fan speed medium	67 %
Channel 9	Output value for fan speed high	100 %
Channel 10	<b>Status feedback for fan speed</b>	
+ Channel 11-20	Status value for fan speed low	33 %
+ Channel 21-30	Status value for fan speed medium	67 %
+ Channel 31-40	Status value for fan speed high	100 %
+ Channel 41-50	1 bit object function for fan speed	<input type="radio"/> Disable <input checked="" type="radio"/> Enable
+ Channel 51-60	1 bit object for fan speed off	<input type="radio"/> Disable <input checked="" type="radio"/> Enable
+ Channel 61-70		
+ Channel 71-80		

Fig.5.2.1.3 Parameter setting of room temperature unit

Parameter “Time period for request room temperature sensor [0...255]min”

This parameter is for setting the time period for read request room temperature sensor. Options: **0..255**

Send read request as default when the device voltage recovery.

#### Parameter “Min./Max. setpoint temperature [5..40]° C”

These two parameters are for setting the adjustable range of the setpoint temperature. If the setpoint temperature beyond the limited range, the will output the limited temperature. Options:

5°C

6°C

...

40°C

**For setpoint temperature, the Min. value must less than the Max., if not, it can not be modified on ETS.**

#### Parameter “Control mode”

This parameter is for setting temperature control mode, support 3 types: heating, cooling and heating/cooling.

Options:

**Heating**

**Cooling**

**Heating and Cooling**

### Fan speed setting

**This setting is visible when “Room temperature unit(with operation mode & fan speed)” is selected**

#### Parameter “Object datatype of 1byte fan speed”

This parameter is for setting the object datatype of 1byte fan speed. Options:

**Fan stage (DPT 5.100)**

**Percentage (DPT 5.001)**

### Output value for fan speed

#### —Parameter “Output value for fan speed low/medium/high”

These parameters are for setting the output value for switching to each fan speed, support 3 fan speeds: low, medium, high. Options are according to the object datatype of previous parameter: **0..255/0..100**

### Status feedback for fan speed

#### —Parameter “Status value for fan speed low/medium/high”

These parameters are for setting the status feedback value of each fan speed, support 3 fan speeds: low,



medium, high. Options are according to the object datatype of previous parameter: **0..255/0..100**

**Note: the out value and status value must meet the condition low<medium<high, if not, they can not be configured on ETS, and display red box warning, as shown as follow:**

Output value for Fan speed low	<input type="text" value="68"/>	%
Output value for Fan speed medium	<input type="text" value="67"/>	%
Output value for Fan speed high	<input type="text" value="100"/>	%

#### Parameter "1 bit object function for fan speed"

This parameter is for setting whether to enable the object datatype of 1bit fan speed. When enabled, the 1 bit object of each fan speed is visible. When three objects value is 0, turn off the fan.

#### Parameter "1 bit object for fan speed off"

This parameter is visible when previous parameter is enabled. Set whether to enable the object "1bit fan speed off" to visible.

#### 5.2.1.4. Parameter of ventilation system

This chapter explains the ventilation system function of KNX channel. Parameters as follow are visible when “Ventilation system” is selected.

--- KNX Gateway for Tuya ZigBee > KNX Channel > Channel 1-10 > Channel 1

+ General	Device type	Ventilation system
- KNX Channel	Description (max 30char.)	
General setting	Device online status reference by	Individual
KNX Channel setting	Time period for request [1..255]	10 min
- Channel 1-10	Default fan speed after ventilation on	Low
Channel 1	Data type of fan speed	<input type="radio"/> 1bit <input checked="" type="radio"/> 1byte
Channel 2	Object datatype of 1byte fan speed	<input type="radio"/> Fan stage (DPT_5.100) <input checked="" type="radio"/> Percentage (DPT_5.001)
Channel 3	Output value for fan speed	
Channel 4	Output value for fan speed low	33 %
Channel 5	Output value for fan speed medium	67 %
Channel 6	Output value for fan speed high	100 %
Channel 7	Status feedback for fan speed	
Channel 8	Status value for fan speed low	33 %
Channel 9	Status value for fan speed medium	67 %
Channel 10	Status value for fan speed high	100 %

Fig.5.2.1.4 Parameter setting of ventilation system

#### Parameter “Default fan speed after ventilation on”

This parameter is for setting the initial fan speed after ventilation on. Switch status of ventilation is read from bus after download or reset, and default as off if can not read. Options:

**Low**

**Medium**

**High**

**Last status**

#### Parameter “Data type of fan speed”

This parameter is for setting the data type of ventilation fan speed. Options:

**1bit**

**1byte**

### Parameter “Object datatype of 1byte fan speed”

This parameter is visible when fan speed datatype is selected “1byte”. Set the datatype of 1byte fan speed object. Options:

**Fan stage (DPT 5.100)**

**Percentage (DPT 5.001)**

### Output value for fan speed

#### Parameter “Output value for fan speed low/medium/high”

These parameters are for setting the output value for switching to each fan speed, support 3 fan speeds: low, medium, high. Value=0 is fan speed off. Options are according to the object datatype of previous parameter:

**0..255/0..100**

### Status feedback for fan speed

#### Parameter “Status value for fan speed low/medium/high”

These parameters are for setting the status feedback value of each fan speed, support 3 fan speeds: low, medium, high. Value=0 is fan speed off. Options are according to the object datatype of previous parameter:

**0..255/0..100**

**Note: the out value and status value must meet the condition  $low < medium < high$ , if not, they can not be configured on ETS, and display red box warning, as shown as follow:**

Output value for Fan speed low	<input type="text" value="68"/>	%
Output value for Fan speed medium	<input type="text" value="67"/>	%
Output value for Fan speed high	<input type="text" value="100"/>	%

### Parameter “Object value of fan speed off/low/medium/high”

This parameter is visible when fan speed datatype is selected “1bit”. Set the control value for switching to each fan speed and the status feedback value. support 4 fan speeds: off, low, medium, high. Device will be update the fan speed display according to the feedback value. Options:

**Low=0,Medium=0,High=0**

**Low=1,Medium=0,High=0**

**Low=0,Medium=1,High=0**

---

**Low=1,Medium=1,High=0**

**Low=0,Medium=0,High=1**

**Low=1,Medium=0,High=1**

**Low=0,Medium=1,High=1**

**Low=1,Medium=1,High=1**

Parameter "Delay between fan speed switch [0..100]\*50ms"

This parameter is visible when fan speed datatype is selected "1bit". Set the delay time between fan speeds switchover. Options: **0..100**

Turn off fan speed before switch the fan speed, and turn on it after the delay time. When delay time is set as 0, it will not turn off first then turn on, but switch to next fan speed directly.

### 5.2.1.5. Parameter of audio control

This chapter explains the audio control function of KNX channel, including the basic and audio control with power on/off. Parameters as follow are visible when “Audio control” or “Audio control(with on/off)” is selected.

The screenshot shows the configuration page for Channel 1. The left sidebar contains a tree view with the following items: General, KNX Channel, General setting, KNX Channel setting, Channel 1-10, Channel 1 (selected), Channel 2, Channel 3, Channel 4, Channel 5, Channel 6, Channel 7, and Channel 8. The main settings area is divided into several sections:

- Device type:** Audio control (dropdown)
- Description (max 30char.):** (text input)
- Device online status reference by:** Individual (dropdown)
- Time period for request [1..255]:** 10 (spin box) min
- Object datatype of absolute volume:**
  - Percentage (DPT 5.001)
  - Percentage (DPT 5.004)
- Output value for play mode:**
  - Output value for play in single cycle: 1 (spin box)
  - Output value for play in order: 2 (spin box)
  - Output value for play in random: 3 (spin box)
- Status feedback for play mode:**
  - Status value for play in single cycle: 1 (spin box)
  - Status value for play in order: 2 (spin box)
  - Status value for play in random: 3 (spin box)

Fig.5.2.1.5 Parameter setting of audio control

#### Parameter “Object datatype of absolute volume”

This parameter is for setting the datatype of audio control object. Options:

**Percentage (DPT 5.001)**

**Percentage (DPT 5.004)**

#### Output value for play mode

##### Parameter “Output value for play in single cycle/order/random”

These parameters are for setting the control value of each mode, including single cycle/order/random play.

Options: **0..255**

#### Status feedback for play mode

##### Parameter “Status value for for play in single cycle/order/random”

These parameters are for setting the status value of each mode, including single cycle/order/random play.

Device will be update the play mode display according to the feedback value. Options: **0..255**

**5.2.1.6. Parameter of sensor function**

This chapter explains the sensor function of KNX channel, including air quality sensor, presence sensor, motion sensor, brightness sensor, I/O sensor and etc.

--- KNX Gateway for Tuya ZigBee > KNX Channel > Channel 1-10 > Channel 1

+ General	Device type	Air quality sensor
- KNX Channel	Description (max 30char.)	<input type="text"/>
General setting	Device online status reference by	Individual
KNX Channel setting	Time period for request [1..255]	10 min
- Channel 1-10	Object datatype of PM2.5	<input type="radio"/> Value in ug/m3(DPT_7.001) <input checked="" type="radio"/> Float value in ug/m3(DPT_9.030)
Channel 1	Object datatype of PM10	<input type="radio"/> Value in ug/m3(DPT_7.001) <input checked="" type="radio"/> Float value in ug/m3(DPT_9.030)
Channel 2	Object datatype of VOC	<input type="radio"/> Value in ug/m3(DPT_7.001) <input checked="" type="radio"/> Float value in ug/m3(DPT_9.030)
Channel 3	Object datatype of CO2	<input type="radio"/> Value in ppm (DPT_7.001) <input checked="" type="radio"/> Float value in ppm(DPT_9.008)
Channel 4		
Channel 5		

Parameter setting of “Air quality sensor”

--- KNX Gateway for Tuya ZigBee > KNX Channel > Channel 1-10 > Channel 1

+ General	Device type	CO2 sensor
- KNX Channel	Description (max 30char.)	<input type="text"/>
General setting	Device online status reference by	Individual
KNX Channel setting	Time period for request [1..255]	10 min
- Channel 1-10	Object datatype of CO2	<input type="radio"/> Value in ppm (DPT_7.001) <input checked="" type="radio"/> Float value in ppm(DPT_9.008)

Parameter setting of “CO2 sensor”

--- KNX Gateway for Tuya ZigBee > KNX Channel > Channel 1-10 > Channel 1

+ General	Device type	PM2.5 sensor
- KNX Channel	Description (max 30char.)	<input type="text"/>
General setting	Device online status reference by	Individual
KNX Channel setting	Time period for request [1..255]	10 min
- Channel 1-10	Object datatype of PM2.5	<input type="radio"/> Value in ug/m3(DPT_7.001) <input checked="" type="radio"/> Float value in ug/m3(DPT_9.030)

Parameter setting of “PM2.5 sensor”



--- KNX Gateway for Tuya ZigBee > KNX Channel > Channel 1-10 > Channel 1

+ General	Device type	VOC sensor
- KNX Channel	Description (max 30char.)	
General setting	Device online status reference by	Individual
KNX Channel setting	Time period for request [1..255]	10 min
- Channel 1-10	Object datatype of VOC	<input type="radio"/> Value in ug/m3(DPT_7.001) <input checked="" type="radio"/> Float value in ug/m3(DPT_9.030)

Parameter setting of "VOC sensor"

--- KNX Gateway for Tuya ZigBee > KNX Channel > Channel 1-10 > Channel 1

+ General	Device type	Presence sensor
- KNX Channel	Description (max 30char.)	
General setting	Device online status reference by	Individual
KNX Channel setting	Time period for request [1..255]	10 min
- Channel 1-10	Object datatype of brightness(lux)	<input type="radio"/> Value in lux (DPT 7.013) <input checked="" type="radio"/> Float value in lux (DPT 9.004)

Parameter setting of "Presence sensor"

--- KNX Gateway for Tuya ZigBee > KNX Channel > Channel 1-10 > Channel 1

+ General	Device type	Motion sensor
- KNX Channel	Description (max 30char.)	
General setting	Device online status reference by	Individual
KNX Channel setting	Time period for request [1..255]	10 min

Parameter setting of "Motion sensor"

--- KNX Gateway for Tuya ZigBee > KNX Channel > Channel 1-10 > Channel 1

+ General	Device type	Brightness sensor
- KNX Channel	Description (max 30char.)	
General setting	Device online status reference by	Individual
KNX Channel setting	Time period for request [1..255]	10 min
- Channel 1-10	Object datatype of brightness(lux)	<input type="radio"/> Value in lux (DPT 7.013) <input checked="" type="radio"/> Float value in lux (DPT 9.004)

Parameter setting of "Brightness sensor"

--- KNX Gateway for Tuya ZigBee > KNX Channel > Channel 1-10 > Channel 1

+ General	Device type	I/O signal
- KNX Channel	Description (max 30char.)	
General setting	Device online status reference by	Individual
	Time period for request [1..255]	10 min

Parameter setting of "I/O signal"

Fig.5.2.1.6 Parameter setting of sensor function

**Parameter “Object datatype of PM2.5”**

This parameter is visible when device type is selected “Air quality sensor” or “PM2.5 sensor”. Set the object datatype of PM2.5. Options:

**Value in ug/m3 (DPT 7.001)**

**Float value in ug/m3 (DPT 9.030)**

**Parameter “Object datatype of PM10”**

This parameter is visible when device type is selected “Air quality sensor”. Set the object datatype of PM10.

Options:

**Value in ug/m3 (DPT 7.001)**

**Float value in ug/m3 (DPT 9.030)**

**Parameter “Object datatype of VOC”**

This parameter is visible when device type is selected “Air quality sensor” or “VOC sensor”. Set the object datatype of VOC. Options:

**Value in ug/m3 (DPT 7.001)**

**Float value in ug/m3 (DPT 9.030)**

**Parameter “Object datatype of CO2”**

This parameter is visible when device type is selected “Air quality sensor” or “CO2 sensor”. Set the object datatype of CO2. Options:

**Value in ppm (DPT 7.001)**

**Float value in ppm (DPT 9.008)**

**Parameter “Object datatype of brightness(lux)”**

This parameter is visible when device type is selected “Presence sensor” or “Brightness sensor”. Set the object datatype of brightness. Options:

**Value in lux (DPT 7.013)**

**Float value in lux (DPT 9.004)**



### 5.2.1.7. Parameter of current metering function

This chapter explains the current metering function of KNX channel. Parameters as follow are visible when device type is selected “Current metering”.

The screenshot shows the configuration page for Channel 1. The breadcrumb path is: KNX Gateway for Tuya ZigBee > KNX Channel > Channel 1-10 > Channel 1. The left sidebar shows a tree view with 'Channel 1' selected. The main content area displays the following settings:

- Device type: Current metering (dropdown menu)
- Description (max 30char.): (empty text field)
- Device online status reference by: Individual (dropdown menu)
- Time period for request [1..255]: 10 (spin box) min
- Object datatype of current: Float value in mA (DPT 9.021) (dropdown menu)
- Object datatype of power:
  - Float value in kW (DPT 9.024)
  - Float value in W (DPT 14.056)

Fig.5.2.1.7 Parameter setting of current metering function

#### Parameter “Object datatype of current”

This parameter is for setting the object datatype of current. Options:

**Value in mA (DPT 7.012)**

**Float value in mA (DPT 9.021)**

**Float value in A (DPT 14.019)**

#### Parameter “Object datatype of power”

This parameter is for setting the object datatype of power. Options:

**Float value in kW (DPT 9.024)**

**Float value in W (DPT 14.056)**

### 5.2.1.8. Parameter of energy metering function

This chapter explains the energy metering function of KNX channel. Parameters as follow are visible when device type is selected “Energy metering”.

--- KNX Gateway for Tuya ZigBee > KNX Channel > Channel 1-10 > Channel 1

+ General	Device type	Current metering
- KNX Channel	Description (max 30char.)	
General setting	Device online status reference by	Individual
KNX Channel setting	Time period for request [1..255]	10 min
- Channel 1-10	Object datatype of current	Float value in mA (DPT 9.021)
Channel 1	Object datatype of power	<input checked="" type="radio"/> Float value in kW (DPT 9.024) <input type="radio"/> Float value in W (DPT 14.056)
Channel 2		

Fig.5.2.1.8 Parameter setting of energy metering function

#### Parameter "Object datatype of current"

This parameter is for setting the object datatype of current. Options:

**Value in mA (DPT 7.012)**

**Float value in mA (DPT 9.021)**

**Float value in A (DPT 14.019)**

#### Parameter "Object datatype of voltage"

This parameter is for setting the object datatype of voltage. Options:

**Float value in mV (DPT 9.020)**

**Float value in V (DPT 14.027)**

#### Parameter "Object datatype of power"

This parameter is for setting the object datatype of power. Options:

**Float value in kW (DPT 9.024)**

**Float value in W (DPT 14.056)**

#### Parameter "Object datatype of energy"

This parameter is for setting the object datatype of energy. Options:

**Value in Wh (DPT 13.010)**

**Value in kWh (DPT 13.013)**

### 5.3. Parameter window “Zigbee Channel”

#### 5.3.1. Parameter window “Zigbee Channel setting”

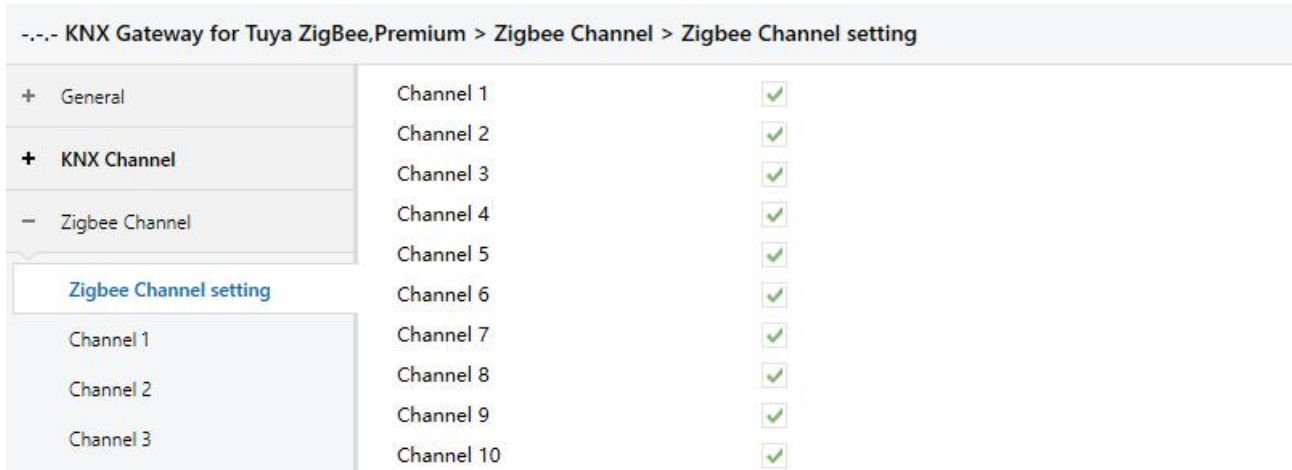

Fig.5.3.1 “Zigbee Channel setting” Parameter window

#### Parameter “Channel 1/2/3/...”

This parameter is for setting the Zigbee device setting. Display corresponding window when enabled. Up to support 32 channels.

Note: Zigbee Channel function only applies to the premium version BTMO-TY/00.3(4).

#### 5.3.2. Parameter window “Channel x” (x=1~32)

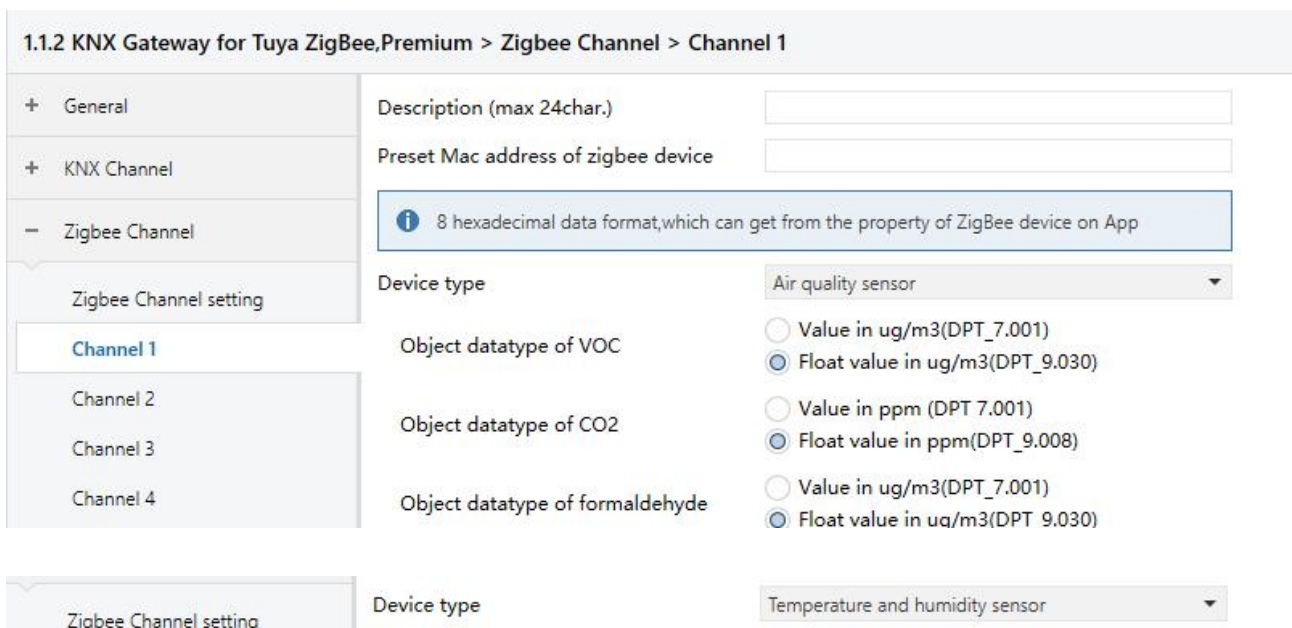

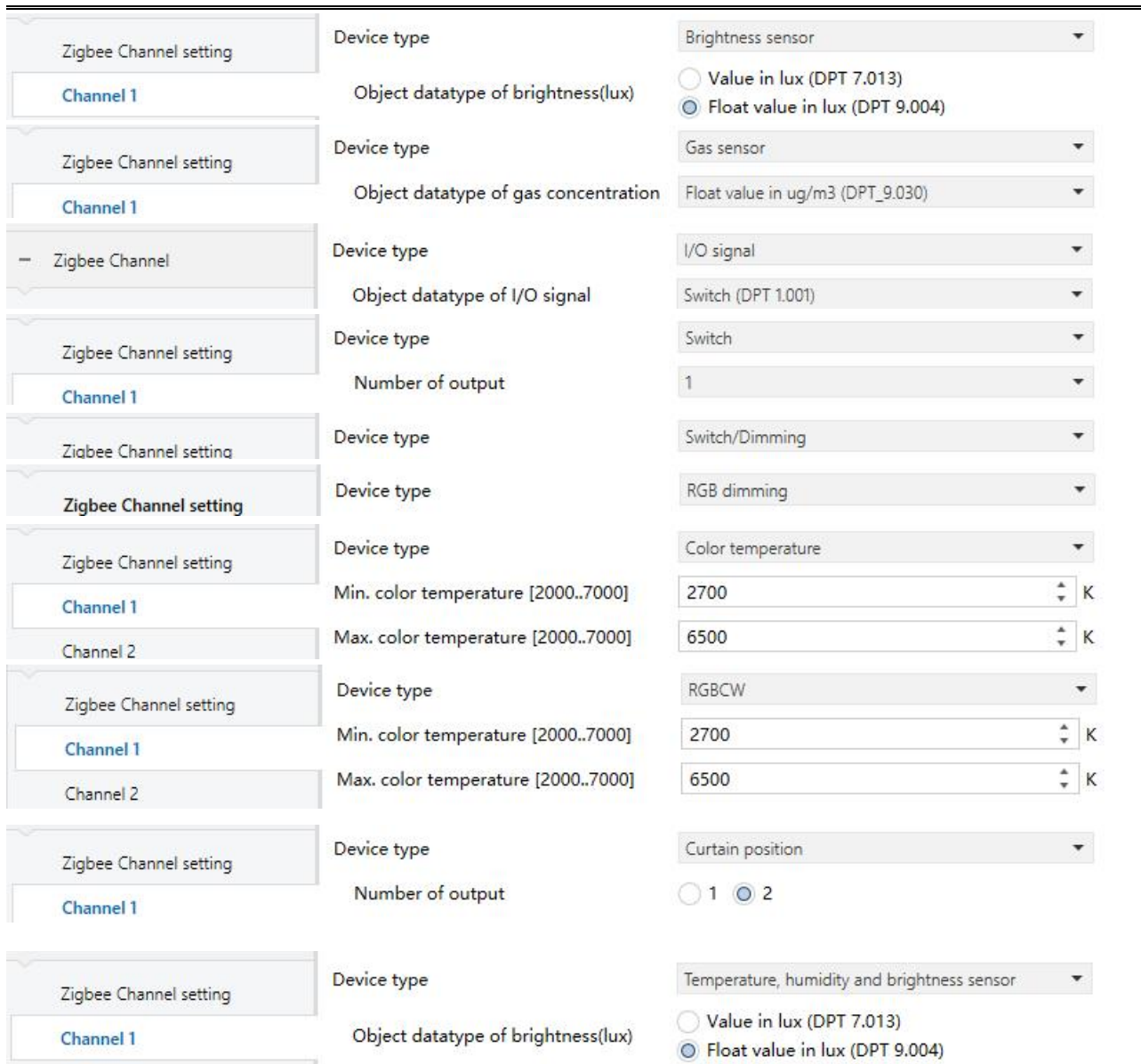

Fig.5.3.2 “Channel setting” Parameter window

Parameter “Description (max 24char.)”

This parameter is for setting the name description for current channel device, up to input 24 characters.

Parameter “Preset Mac address of zigbee device”

This parameter is for presetting MAC address of the current channel.

**i** 8 hexadecimal data format, which can get from the property of ZigBee device on App

Parameter “Device type”

This parameter is for setting the device type of the Zigbee channel. Options:

**Air quality sensor**

**Temperature and humidity sensor**

Brightness sensor

Gas sensor

I/O signal

Switch

Switch/Dimming

RGB dimming

Color temperature

RGBCW

Curtain position

Temperature, humidity and brightness sensor

#### Parameter "Object datatype of VOC"

This parameter is visible when "Air quality sensor" is selected. Set the object datatype of VOC. Options:

**Value in ug/m3 (DPT 7.001)**

**Float value in ug/m3 (DPT 9.030)**

#### Parameter "Object datatype of CO2"

This parameter is visible when "Air quality sensor" is selected. Set the object datatype of CO2. Options:

**Value in ppm (DPT 7.001)**

**Float value in ppm (DPT 9.008)**

#### Parameter "Object datatype of formaldehyde"

This parameter is visible when "Air quality sensor" is selected. Set the object datatype of formaldehyde.

Options:

**Value in ppm (DPT 7.001)**

**Float value in ppm (DPT 9.008)**

#### Parameter "Object datatype of brightness(lux)"

This parameter is visible when "Brightness sensor" or "Temperature, humidity and brightness sensor" is selected. Set the object datatype of brightness. Options:

**Value in lux (DPT 7.013)**

**Float value in lux (DPT 9.004)**

**Parameter “Object datatype of gas concentration”**

This parameter is visible when “Gas sensor” is selected. Set the object datatype of gas concentration.

Options:

**Value in ug/m3 (DPT 7.001)**

**Float value in ppm (DPT 9.008)**

**Float value in ug/m3 (DPT 9.030)**

**Parameter “Object datatype of I/O signal”**

This parameter is visible when “I/O signal” is selected. Set the object datatype of I/O signal. Options:

**Switch (DPT 1.001)**

**Boolean (DPT 1.002)**

**Alarm (DPT 1.005)**

**Occupancy (DPT 1.018)**

**Window/door (DPT 1.019)**

**Parameter “Number of output”**

This parameter is visible when “Switch” or “Curtain position” is selected. Set the output channel of Switch or Curtain.

Options for switch output: **1 / 2 / 3**

Options for curtain output: **1 / 2**

**Parameter “Min. color temperature [2000..7000]K”****Parameter “Max. color temperature [2000..7000]K”**

These two parameters are visible when “Color temperature” or “RGBCW” is selected. Set the upper and lower limit threshold value of color temperature. Options: **2000..7000**

When the minimum value and maximum value are set incorrect, The selected range is the whole range, for example the minimum value is larger than the maximum value. There is only one value when equal.



## 5.4. Parameter window “Room temperature controller”

### 5.4.1. Parameter window “RTC Channel setting”

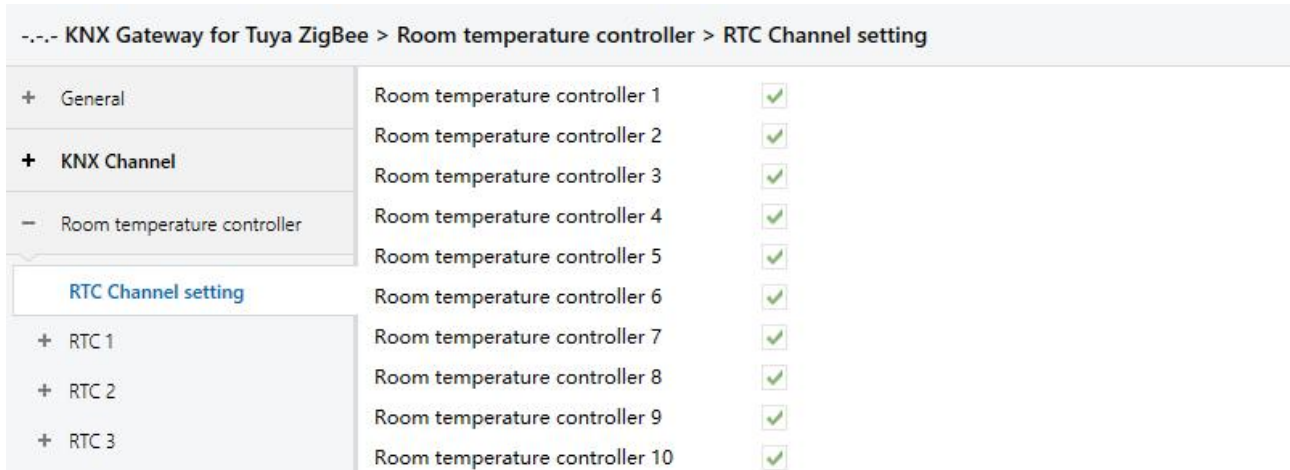

Fig.5.4.1 “RTC Channel setting” Parameter window

### Parameter “Room temperature controller 1/2/3/...”

This parameter is for setting whether to enable the setting interface of RTC device, display corresponding interface. Up to enable 10 channels.

### 5.4.2. Parameter window “RTC x”(x=1~10)

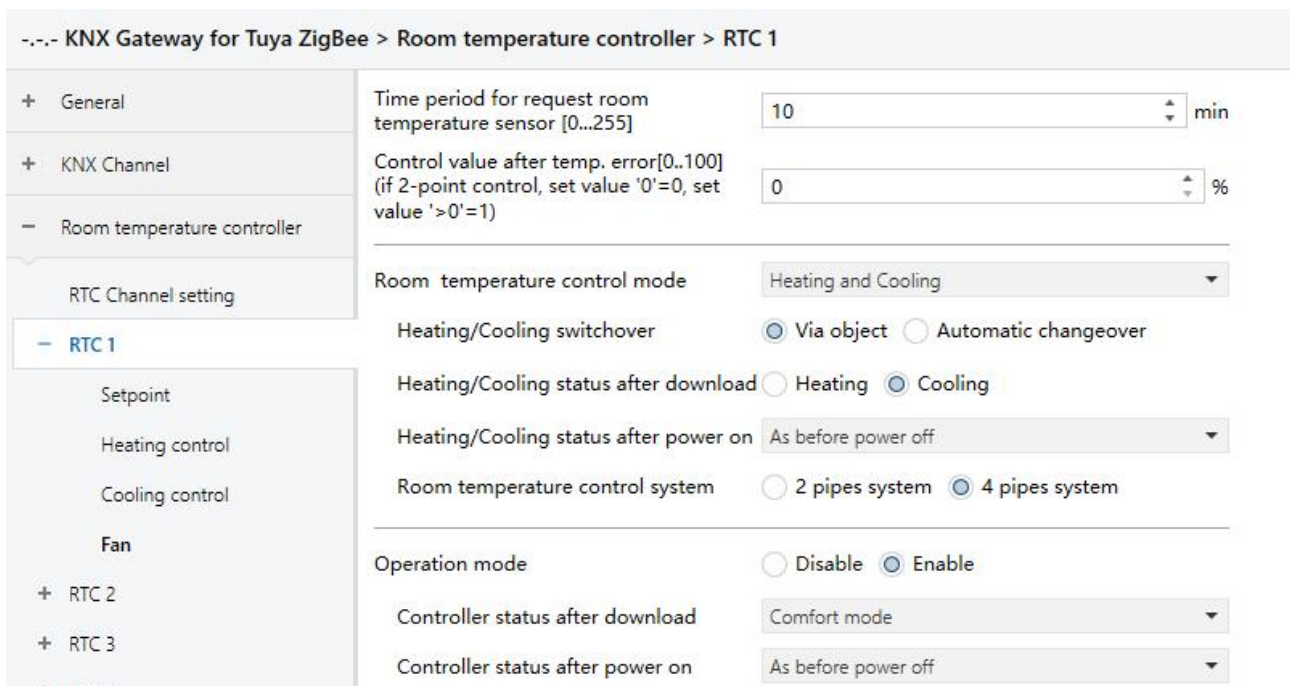

Fig.5.4.2(1) “RTC 1” parameter window

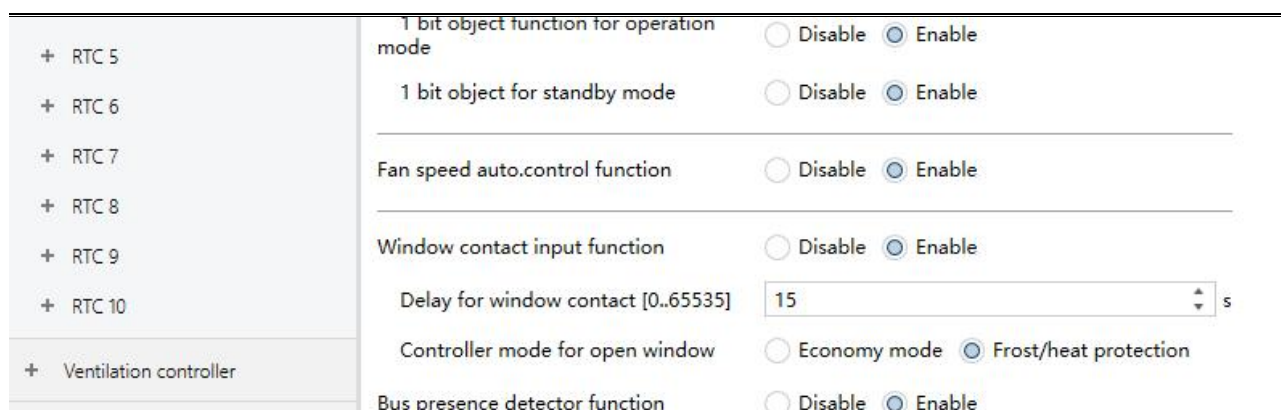

Fig.5.4.2(2) “RTC 1” parameter window

**Parameter “Time period for request room temperature sensor [0..255]min”**

This parameter is for setting the time period for read request external temperature sensor. Send read request to external temperature sensor after the device voltage recovery or finish programming. Options: **0..255**

**Parameter “Control value after temp. error[0..100]% (if 2-point control, set value '0'=0, set value '>0'=1)”**

This parameter is for setting the control value when temperature error occur. Options: **0..100**

If 2-Point control, then the parameter value is 0, as well as the control value; if the parameter value is more than 0, then the control value will be 1.

**Parameter “Room temperature control mode”**

This parameter is for setting RTC control mode, support 3 types: heating, cooling and heating/cooling.

Options:

**Heating**

**Cooling**

**Heating and Cooling**

Heating and Cooling: heating and cooling are available. At the same time, four parameters as follow are visible.

**Parameter “Heating/Cooling switchover”**

This parameter is for setting the switchover way of Heating/Cooling. Options:

**Via object**

**Automatic changeover**

**Parameter “Heating/Cooling status after download”**

This parameter is for setting the heating/cooling control mode of device after download.



Options:

**Heating**

**Cooling**

——Parameter “Heating/Cooling status after power on”

This parameter is for setting the heating/cooling control mode of device after voltage recovery. Options:

**Heating**

**Cooling**

**As before power off**

As before voltage failure: When the device is reset after power on, the control mode will recover as before voltage failure or restart. If it is the first time the device is used or a newly enabled function page, the control mode after the device is started is in an uncertain state, and it needs to be manually selected at this time.

——Parameter “Room temperature control system”

This parameter is for setting the type of RTC control system, that is, pipe types of fan coil water inlet/outlet.

Options:

**2 pipes system**

**4 pipes system**

2 pipes system: Shares an inlet and outlet pipe for heating and cooling, that is, both hot and cold water are controlled by a valve.

4 pipes system: Has its own inlet and outlet pipes for heating and cooling, and two valves are needed to control the entry and exit of hot water and cold water respectively.

Parameter “Operation mode”

This parameter is for setting whether to enable RTC operation mode. Options:

**Disable**

**Enable**

When enable, support 4 modes: comfort, standby, economy and frost/heat protection. Support datatype of 1bit and 1byte, and preset a operation mode when download and voltage recovery.

**Four parameters as follow are visible when RTC operation mode enabled.**

**—Parameter “Controller status after download”**

This parameter is for setting the operation mode after download. Options:

**Standby mode**

**Comfort mode**

**Economy mode**

**—Parameter “Controller status after power on”**

This parameter is for setting the operation mode after voltage recovery. Options:

**Standby mode**

**Comfort mode**

**Economy mode**

**Frost/heat protection**

**As before power off**

**—Parameter “1 bit object function for operation mode”**

This parameter is for setting whether to enable 1 bit objects of operation mode are visible. Options:

**Disable**

**Enable**

**—Parameter “1 bit object for standby mode”**

This parameter is visible when previous parameter enabled. Set whether to enable 1 bit object of standby mode is visible. Options:

**Disable**

**Enable**

**Three parameters as follow are visible when RTC operation mode disabled.**

**—Parameter “ Initial setpoint temperature ( ° C)”**

This parameter is for setting the initial value of setpoint temperature. Options:

**10.0**

**10.5**

**...**

**35.0**

When initial setpoint temperature is less than the min. setpoint temperature, display following warning:

✘ The setpoint is less than minimum,so minimum will regard as setpoint in fact

When initial setpoint temperature is greater than the max. setpoint temperature, display following warning:

✘ The setpoint is greater than maximum,so maximum will regard as setpoint in fact

#### Automatic H/C mode changeover dead zone

##### —Parameter “Upper/Lower dead zone”

These two parameters are visible when control mode “Heating and Cooling” is selected, and “Automatic changeover” is selected. Setting the dead zone range of auto switchover heating/cooling. Options:

**0.5°C**

**1.0°C**

...

**10°C**

Under heating control, when the actual temperature(T) greater than or equal to the setpoint temperature + the upper dead zone, then mode heating switch to cooling;

Under cooling control, when the actual temperature(T) less than or equal to the setpoint temperature + the upper dead zone, then mode cooling switch to heating.

#### Parameter “Fan speed auto control function”

This parameter is for setting whether to enable fan auto control interface is visible. Options:

**Disable**

**Enable**

#### Parameter “Window contact input function”

This parameter is visible when operation mode enabled. Set whether to link to window contact status.

Options:

**Disable**

**Enable**

#### —Parameter “Delay for window contact [0..65535]s”

This parameter is visible when operation mode and window contact input function are enabled. Set the delay time to window contact detection. That is, when receive a telegram “window open”, the controller will regard that

as a valid signal and execute the behaviour after this delay time. Options: **0..65535**

#### Parameter "Controller mode for open window"

This parameter is visible when operation mode and window contact input function are enabled. If window status is open, perform corresponding operation according to configuration. Options:

**Economy mode**

**Frost/heat protection**

Other control telegram receiving will be record during window is open and performed after receiving the telegram "Close window". If there is no telegram receiving when window is open, return to the mode before opening the window.

#### Parameter "Bus presence detector function"

This parameter is visible when operation mode enabled. Set whether to link to bus presence detector status. Options:

**Disable**

**Enable**

If presence is detected, enter the comfort mode, and it will be restored to original mode after leaving. If there is a telegram/manual operation to adjust the mode during the period, the telegram is logged in the background, and it will be exited comfort mode and restored to the mode after leaving. If there is no telegram receiving during timing, return to original mode. (If receive the presence status cyclically, comfort mode can not be re-triggered, and only can be after leaving.)

#### Parameter "Min./Max. setpoint temperature [5..40] ° C"

These parameters are visible when operation mode disabled. Set to limit the adjustable range of the setpoint temperature. If the setpoint temperature beyond the limited range, the will output the limited temperature.

Options:

**5°C**

**6°C**

**...**

**40°C**

These parameters are display below the parameters settings interface "Setpoint" when enable operation mode.

**For setpoint temperature, the Min. value must less than the Max., if not, it can not be modified on ETS.**

### 5.4.1.1. Parameter window “Setpoint”

--- KNX Gateway for Tuya ZigBee > Room temperature controller > RTC 1 > Setpoint

Mode	Setpoint temperature [5...40] °C
Heating - comfort mode	21
Heating - standby mode	19
Heating - economy mode	17
Heating - frost protection mode	7
Cooling - comfort mode	23
Cooling - standby mode	25
Cooling - economy mode	27
Cooling - heat protection mode	35
Min. setpoint temperature [5..40]	5
Max. setpoint temperature [5..40]	40

Note: The heating setpoint must be always less than the cooling setpoint

Fig.5.4.1.1 “Setpoint” parameter window

Parameters of this window are visible when RTC operation mode enabled, display according to control mode.

The temperature setpoint value uses the way of absolute adjustment.

Parameter “Setpoint temperature in comfort mode [5...40] ° C”

Parameter “Setpoint temperature in standby mode [5...40] ° C”

Parameter “Setpoint temperature in economy mode [5...40] ° C”

Parameter “Setpoint temperature in frost protection mode [5...40] ° C”(for heating)

Parameter “Setpoint temperature in heat protection mode [5...40] ° C”(for cooling)

These parameters are for setting the temperature setpoint value of each mode. Options:

5°C

6°C

...

40°C

 Note: The heating setpoint must be always less than the cooling setpoint.

When “Heating and Cooling” is selected, whether it is manual changeover, bus changeover or automatic changeover, the heating setpoint value must be less than or equal to the cooling of the same operation mode, if not, it can not be configured on ETS.

1. When the ambient temperature is higher than the setpoint temperature of current mode, it is changed to cooling mode; When the ambient temperature is lower than the setpoint temperature of current mode, it is changed to heating mode.

2. In the same operation mode, the setpoint temperature difference between cooling and heating remains constant, whether it is written on the bus or adjusted on the panel. That is, when adjust the setpoint temperature, it need to update cooling and heating setpoint temperature of current operation mode at the same time.

3. When the bus is received setpoint temperature, it is still necessary to limit the value according to the high and low thresholds, that is heating and cooling temperature neither can not be lower than the min., or can not be higher than the max.. If parameters configuration of ETS is not met the condition, it will be noted warnings:

When the setpoint temperature of comfort/standby/economy mode is less than the min. setpoint temperature, display following warning:

 The setpoint is less than minimum,so minimum will regard as setpoint in fact

When the setpoint temperature of comfort/standby/economy mode is greater than the max. setpoint temperature, display following warning:

 The setpoint is greater than maximum,so maximum will regard as setpoint in fact

**Note:** for protection mode, the setpoint temperature is only configured via ETS, and not limited with the min./max. value. When the received setpoint value from bus is different from the ETS configuration, the value is not updated and returned to the current setpoint temperature, to update synchronously to other devices on the bus.

5.4.1.2. Parameter window “Heating/Cooling control”

--- KNX Gateway for Tuya ZigBee > Room temperature controller > RTC 1 > Heating/Cooling control

<ul style="list-style-type: none"> <li>+ General</li> <li>+ KNX Channel</li> <li>- Room temperature controller             <ul style="list-style-type: none"> <li>RTC Channel setting</li> <li>- RTC 1                 <ul style="list-style-type: none"> <li>Setpoint</li> <li><b>Heating/Cooling control</b></li> <li>Fan</li> </ul> </li> <li>+ RTC 2</li> </ul> </li> </ul>	<p>Type of heating/cooling control: Switching on/off(use 2-point control)</p> <p>Invert control value: <input checked="" type="radio"/> No <input type="radio"/> Yes</p> <p><b>Heating</b></p> <p>Lower Hysteresis [0...200]*0.1: 10 °C</p> <p>Upper Hysteresis [0...200]*0.1: 10 °C</p> <p><b>Cooling</b></p> <p>Lower Hysteresis [0...200]*0.1: 10 °C</p> <p>Upper Hysteresis [0...200]*0.1: 10 °C</p> <p>Cyclically send control value [0...255]: 10 min</p>
<ul style="list-style-type: none"> <li>+ General</li> <li>+ KNX Channel</li> <li>- Room temperature controller             <ul style="list-style-type: none"> <li>RTC Channel setting</li> <li>- RTC 1                 <ul style="list-style-type: none"> <li>Setpoint</li> <li><b>Heating/Cooling control</b></li> <li>Fan</li> </ul> </li> <li>+ RTC 2</li> </ul> </li> </ul>	<p>Parameter setting of “Switching on/off(use 2-point control)”</p> <p>Type of heating/cooling control: Switching PWM(use PI control)</p> <p>Invert control value: <input checked="" type="radio"/> No <input type="radio"/> Yes</p> <p>PWM cycle time [1...255]: 15 min</p> <p>Heating speed: User defined</p> <p>Proportional range [10..100]*0.1: 40 °C</p> <p>Reset time [0..255]: 150 min</p> <p>Cooling speed: User defined</p> <p>Proportional range [10..100]*0.1: 40 °C</p> <p>Reset time [0..255]: 150 min</p> <p>Cyclically send control value [0...255]: 10 min</p>
<ul style="list-style-type: none"> <li>+ General</li> <li>+ KNX Channel</li> <li>- Room temperature controller             <ul style="list-style-type: none"> <li>RTC Channel setting</li> <li>- RTC 1                 <ul style="list-style-type: none"> <li>Setpoint</li> <li><b>Heating/Cooling control</b></li> <li>Fan</li> </ul> </li> <li>+ RTC 2</li> </ul> </li> </ul>	<p>Parameter setting of “Switching PWM(use PI control)”</p> <p>Type of heating/cooling control: Continuous control(use PI control)</p> <p>Invert control value: <input checked="" type="radio"/> No <input type="radio"/> Yes</p> <p>Heating speed: User defined</p> <p>Proportional range [10..100]*0.1: 40 °C</p> <p>Reset time [0..255]: 150 min</p> <p>Cooling speed: User defined</p> <p>Proportional range [10..100]*0.1: 40 °C</p> <p>Reset time [0..255]: 150 min</p> <p>Send control value on change by [0...100,0=inactive]: 4 %</p> <p>Cyclically send control value [0...255]: 10 min</p>

Parameter setting of “Continuous control(use PI control)”  
 Fig.5.4.1.2(1) “Heating/Cooling control” parameter window

Parameters of this window display according to control mode and control system(2 pipe or 4pipe).

## Parameter "Type of heating/cooling control"

This parameter is for setting the type of heating/cooling control. Different control types are suitable for controlling different temperature controllers. Options:

**Switching on/off(use 2-point control)**

**Switching PWM(use PI control)**

**Continuous control(use PI control)**

## Parameter "Invert control value"

This parameter is for setting whether to invert control value or normal sending control value, so that the control value will be suitable for the valve type. Options:

**No**

**Yes**

Yes: Sending the control value to the bus through objects after inverting the control value.

**Two parameters as follow are suitable for 2 point control:**

---Parameter "Lower Hysteresis [0..200]\*0.1 ° C "

---Parameter "Upper Hysteresis [0..200]\*0.1 ° C "

These two parameters are for setting the lower/upper hysteresis temperature in HVAC heating or cooling.

Options: **0..200**

**Under heating control,**

**When the actual temperature(T) > the setting temperature + the upper hysteresis temperature, then will stop heating;**

**When the actual temperature(T) < the setting temperature - the lower hysteresis temperature, then will start heating.**

For example, the lower hysteresis temperature is 1°C, the upper hysteresis temperature is 2°C, the setting temperature is 22°C, if T is higher than 24°C, then it will stop heating; if T is lower than 20°C, then it will start heating; if T is between 21~24°C, then it will maintain the previous status.

**Under the cooling control,**

**When the actual temperature (T) < the setting temperature -the lower hysteresis temperature, then will stop cooling;**



When the actual temperature (T) > the setting temperature + the upper hysteresis temperature, then will start cooling.

For example, the lower hysteresis temperature is 1°C, the upper hysteresis temperature is 2°C, the setting temperature is 26°C, if T is lower than 25°C, then it will stop cooling; if T is lower than 28°C, then it will start cooling; if T is between 28~25°C, then it will maintain the previous status.

**2-point control mode is a very simple control mode. When adopting this control mode, it is necessary to set the upper hysteresis temperature and the lower hysteresis temperature through parameters. When setting the hysteresis temperature, the following effects need to be considered:**

1. When hysteresis interval is small, the temperature range will be small, however, frequent sending of control value will bring large load to the bus;
2. When hysteresis interval is large, the switch switching frequency will be low, but it is easy to cause uncomfortable temperature change.

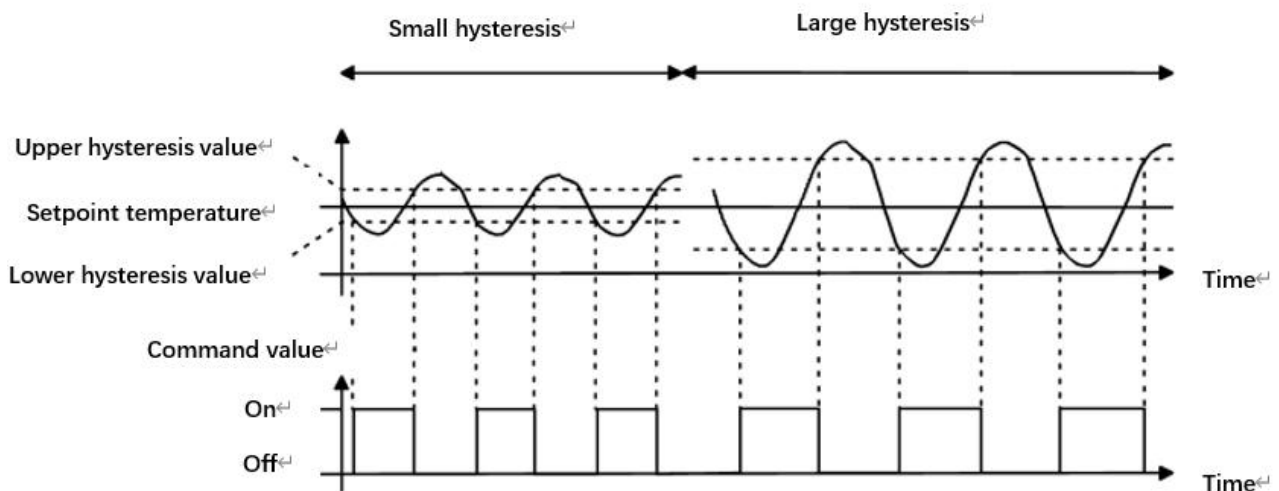

Fig.5.4.1.2(2) Effects of hysteresis on control value switch action(heating) under 2-point control mode

**Two parameters as follow are suitable for PI control:**

- Parameter "Heating speed"
- Parameter "Cooling speed"

These two parameters are for setting the responding speed of heating or cooling PI controller. Different responding speeds are suitable for different environments.

Options:

**Hot water heating (5K/150min)**

**Underfloor heating (5K/240 min)**

**Electrical heating (4K/100min)**

**Split unit (4K/90min)**

**Fan coil unit (4K/90min)**

**User defined**

Options:

**Cooling ceiling (5K/240min)**

**Split unit (4K/90min)**

**Fan coil unit(4K/90min)**

**User defined**

—Parameter “Proportional range [10..100]\*0.1 ° C”(P value)

—Parameter “Reset time [0..255]min”(I value)

These two parameters are visible when “User defined” is selected. Set the PI value of PI controller.

Options: **10..100 (P value)**

Options: **0..255 (I value)**

—Parameter “PWM cycle time [1..255]min”

This parameter is only visible when the control type is “Switching PWM(use PI control)”. Set the period of the control object cycle to send the switch value, the object sends the switch value according to the duty cycle of the control value. For example, if the set period is 10 min and the control value is 80%, then the object will send an open telegram for 8 min. If the control value is changed, the time duty ratio of the on/ off telegram of the object will also change, but the period is still the time of parameter setting.

Options: **1..255**

The PI values of “Switching PWM (use PI control)” and “Continuous control (use PI control)” are the same, only different in control objects, the control object of “Continuous control” output PI value(1byte) directly, while the control value of “Switching PWM” output a “on/off” telegram according to the duty cycle of the control value.

---Parameter “Send control value on change by {0..100.0=inactive}%”

This parameter is visible when control type is “Continuous control (use PI control)”, for setting the changing value of the control value to be sent to the bus. Options: **0..100, 0=inactive**

Parameter “Cyclically send control value {0..255}min”

This parameter is for setting the period for cyclically sending the control value to the bus. Options: **0..255**

**In PI control mode, the predefined control parameters of each PI controller in heating or cooling system are recommended as follows:**

**(1) Heating**

Heating type	P value	I value(integration time)	Recommended PI control type	Recommended PWM period
Hot water Heating	5K	150min	Continuous/PWM	15min
Underfloor heating	5K	240min	PWM	15-20min
Electrical heating	4K	100min	PWM	10-15min
Split unit	4K	90min	PWM	10-15min
Fan coil unit	4K	90min	Continuous	--

**(2) Cooling**

Cooling type	P value	I value(integration time)	Recommended PI control type	Recommended PWM period
Cooling ceiling	5K	240min	PWM	15-20min
Split unit	4K	90min	PWM	10-15min
Fan coil unit	4K	90min	Continuous	--

**(3) User defined**

When the parameter“Heating/Cooling speed” is set to “User defined”, the parameter value of P (scale factor) and I (integration time) can be set through the parameter. When adjusting the parameters, refer to the fixed PI value mentioned in the above table. Even if the control parameters are adjusted slightly, the control behavior will

be significantly different.

In addition, the integration time should be set properly. If the integration time is too long, the adjustment will be slow, and the oscillation will not be obvious; if the integration time is too small, the adjustment will be fast, but the oscillation will occur. 0 means the integral term is not used.

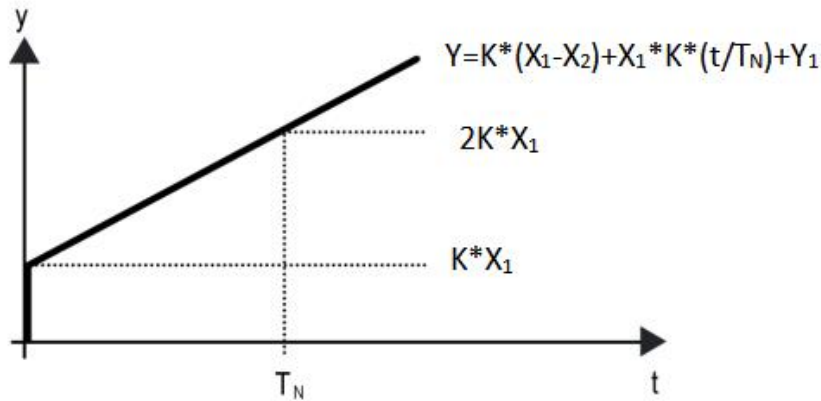

Fig.5.4.3 (7) control value of PI control mode

Y: control value

Y1: last control value

X1: temperature deviation = set temperature - actual temperature

X2: last temperature deviation = set temperature - actual temperature

T<sub>N</sub>: integration time

K: scale factor (the scale factor is not zero)

PI control algorithm:  $Y = K * (X1-X2) + X1 * K * t / T_N + Y1$

When the integration time is set to zero, the PI control algorithm is:  $Y = K (X1-X2) + Y2$

**Setting and influence of user-defined parameters:**

Parameter setting	Effect
K: If the scale range is too small	Quick adjustment, and overshoot will occur
K: If the scale range is too small	Slow adjustment, but no overshoot
T <sub>N</sub> : If the integration time is too short	Quick adjustment, but there will be oscillation
T <sub>N</sub> : If the integration time is too long	Slow adjustment, no obvious oscillation

### 5.4.1.3. Parameter window “Fan”

--- KNX Gateway for Tuya ZigBee > Room temperature controller > RTC 1 > Fan

+ General	Auto. operation on object value	<input checked="" type="radio"/> Auto=1/Man.=0	<input type="radio"/> Auto=0/Man.=1
+ KNX Channel	<b>Fan speed output setting</b>		
- Room temperature controller	Object datatype of 1byte fan speed	<input type="radio"/> Fan stage (DPT_5.100)	<input checked="" type="radio"/> Percentage (DPT_5.001)
RTC Channel setting	Output value for fan speed low	33	%
- RTC 1	Output value for fan speed medium	67	%
Setpoint	Output value for fan speed high	100	%
Heating/Cooling control	<b>Fan speed output setting</b>		
<b>Fan</b>	Condition setting for using 2-point control		
+ RTC 2	Temperature difference speed OFF<-->low [1..200]*0.1	20	°C
+ RTC 3	Temperature difference speed low<-->medium [1..200]*0.1	30	°C
+ RTC 4	Temperature difference speed medium<-->high [1..200]*0.1	40	°C
+ RTC 5	Hysteresis temperature difference in [0..50]*0.1	10	°C
+ RTC 6	Condition setting for using PI control		
+ RTC 7	Threshold value speed OFF<-->low [1..255]	80	
+ RTC 8	Threshold value speed low<-->medium [1..255]	150	
+ RTC 9	Threshold value speed medium<-->high [1..255]	200	
+ RTC 10	Hysteresis threshold value in +/-[0..50]	10	
+ Ventilation controller	Minimum time in fan speed [0..65535]	60	s
+ Logic			

Fig.5.4.1.3 “Fan” parameter window

Parameters of this window are visible when fan auto control enabled.

#### Parameter “Auto. operation on object value”

This parameter is for setting the telegram value to activate automatic operation. Options:

**Auto=1/Man.=0**

**Auto=0/Man.=1**

Auto=1/Man.=0: When the object “Fan automatic operation” receives the telegram value “0”, activate the automatic operation, when receive “1”, exit the automatic operation.

Auto=0/Man.=1: When the object “Fan automatic operation” receives the telegram value “1”, activate the automatic operation, when receive “0”, exit the automatic operation.

**After power-on, automatic operation is not activated by default.**

## Fan speed output setting

Parameter "Object datatype of 1byte fan speed"

This parameter is for setting the object datatype of 1 byte fan speed. Options:

**Fan stage (DPT 5.100)**

**Percentage (DPT 5.001)**

---Parameter "Output value for fan speed low/medium/high"

These three parameters are for setting the value sent for each fan speed switchover. Fan speed off when value is 0. Options according to fan object datatype: **1..255 /1..100**

**Note: the out value and status value must meet the condition low<medium<high, if not, they can not be configured on ETS, and display red box warning, as shown as follow:**

Output value for Fan speed low	<input type="text" value="68"/>	%
Output value for Fan speed medium	<input type="text" value="67"/>	%
Output value for Fan speed high	<input type="text" value="100"/>	%

## Fan speed control setting

### Condition setting for using 2-point control

Under 2-point control, controller will decide the fan power on/off or fan speed according to the temperature difference between the actual temperature and setpoint temperature.

Cooling: Temperature difference = actual temperature - setpoint temperature;

Heating: Temperature difference = setpoint temperature - actual temperature.

Parameter "Temperature difference speed OFF<-->low [1..200] \*0.1° C"

This parameter is for setting the temperature difference between off-fan and low-level fan speeds.

Options: **1..200**

If the temperature difference is greater than or equal to this setting temperature difference, low-level fan speed will start running; if less than this setting temperature difference, the fan will be turned off.

Parameter "Temperature difference speed low<-->medium [1..200] \*0.1° C"

Define the temperature difference for switching the fan speed to medium fan speed, if the control value is greater than or equal to this setting temperature difference, the medium fan speed will start running.

Options: **1..200**

Parameter "Temperature difference speed medium<->high [1..200] \*0.1° C"

Define the temperature difference for switching the fan speed to high fan speed, if the control value is greater than or equal to this setting temperature difference, the high fan speed will start running. Options: **1..200**

Parameter "Hysteresis temperature difference in [0..50] \*0.1° C"

This parameter is for setting the hysteresis value of the temperature difference, which can avoid the unnecessary action of the fan when the control value fluctuates near the temperature difference. Options: **0..50**

If value is 0, no hysteresis. Fan switch to speed once control value greater than temperature difference;

Suppose that hysteresis value is 0.5°C and the temperature difference is 1°C, then the upper limit temperature difference 1.5°C (Temperature difference+Hysteresis value) and the lower limit temperature difference 0.5°C (Temperature difference-Hysteresis value). When the control value is between 0.5°C~1.5°C, fan action will not be caused, and the previous status will still be maintained. Only less than 0.5°C or greater than or equal to 1.5°C will change the running status of the fan.

### Condition setting for using PI control

Under PI control, control value is PI operated within program, controller will power on/off fan or switch fan speed according to the threshold range of the control values.

Parameter "Threshold value speed OFF<->low [1..255]"

Define threshold value for off-fan and low-level fan speeds, options: **1..255**

If the control value is greater than or equal to this setting threshold value, low-level fan speed will start running; if the control value is less than this setting threshold value, the fan will be turned off.

Parameter "Threshold value speed low<->medium [1..255]"

Define the threshold value for switching the fan speed to medium fan speed, if the control value is greater than or equal to this setting threshold, the medium fan speed will start running. Options: **1..255**

Parameter "Threshold value speed medium<->high [1..255]"

Define the threshold for switching the fan speed to high fan speed, if the control value is greater than or equal to this setting threshold, the high fan speed will start running. Options: **1..255**

**Tip: The controller evaluates the threshold in ascending order.**

**First check →OFF <->low fan speed threshold →low fan speed <->medium fan speed →medium fan**

---

speed <-> high fan speed.

The correctness of functional execution is guaranteed only in this case:

The threshold of OFF <-> low fan speed is lower than that of low fan speed <-> medium fan speed, and the threshold of low fan speed <-> medium fan speed is lower than that of medium fan speed <-> high fan speed.

Parameter "Hysteresis threshold value in +/-[0..50]"

This parameter is for setting the hysteresis value of the threshold value, which can avoid the unnecessary action of the fan when the control value fluctuates near the threshold. Options: **0..50**

If value is 0, no hysteresis. Fan switch to speed once control value greater than threshold value;

Suppose that hysteresis value is 10 and the threshold is 50, then the upper limit threshold 60 (Threshold value+Hysteresis value) and the lower limit threshold 40 (Threshold value-Hysteresis value). When the control value is between 40 ~60, fan action will not be caused, and the previous status will still be maintained. Only less than 40 or greater than or equal to 60 will change the running status of the fan.

Parameter "Minimum time in fan speed [0..65535]s"

Defines the residence time of the fan from the current fan speed to a higher fan speed or lower fan speed, that is, the minimum time for a fan speed operation.

If you need to switch to another fan speed, you need to wait for this period of time before switching.

If the current fan speed has been running long enough, the fan speed can be changed quickly.

Options: **0..65535**

0: there is no minimum running time, but the delay switching time of fan speed still needs to be considered.

**Note: The residence time for this parameter setting is only enabled in Auto mode.**



## 5.5. Parameter window “Ventilation controller”

### 5.5.1. Parameter window “Control setting”

--- KNX Gateway for Tuya ZigBee > Ventilation controller > Controller setting

+ General	Ventilation controller	<input checked="" type="checkbox"/>
+ KNX Channel	Auto.operation on object value	<input checked="" type="radio"/> Auto=1/Man.=0 <input type="radio"/> Auto=0/Man.=1
+ Room temperature controller	State of Auto.operation after startup	<input checked="" type="radio"/> Disable <input type="radio"/> Enable
- Ventilation controller	<b>Fan speed output setting</b>	
	Data type of fan speed	<input type="radio"/> 1bit <input checked="" type="radio"/> 1byte
	Object datatype of 1byte fan speed	<input type="radio"/> Fan stage (DPT_5.100) <input checked="" type="radio"/> Percentage (DPT_5.001)
	Output value for fan speed low	33 %
	Output value for fan speed medium	67 %
	Output value for fan speed high	100 %
	<b>Fan speed control setting</b>	
	Control value reference from	PM2.5
	Object datatype of PM2.5	<input checked="" type="radio"/> Value in ug/m3(DPT_7.001) <input type="radio"/> Float value in ug/m3(DPT_9.030)
	Time period for request control value [0...255]	10 min
	The fan speed status when the control value error	Off
	Threshold value OFF<-->speed low [1...999]	35
	Threshold value speed low<-->medium [1...999]	75
	Threshold value speed medium<-->high [1...999]	115
	Hysteresis value is threshold value in +/- [10...30]	10
	Minimum time in fan speed [0...65535]	10 s

Fig.5.5.1 “Control setting” parameter window

#### Parameter “Ventilation controller”

This parameter is for setting whether to enable ventilation controller, to realize the automatic control of the fan speed, and link the fan speed to the detection value of PM2.5 or CO2, VOC. Parameters as follow are visible when enabled.

#### Parameter “Auto. operation on object value”

This parameter is for setting the telegram value to activate automatic operation. Options:

**Auto=1/Man.=0**

**Auto=0/Man.=1**

Auto=1/Man.=0: When the object “Fan automatic operation” receives the telegram value “0”, activate the automatic operation, when receive “1”, exit the automatic operation.

Auto=0/Man.=1: When the object “Fan automatic operation” receives the telegram value “1”, activate the automatic operation, when receive “0”, exit the automatic operation.

**After power-on, automatic operation is not activated by default.**

## Parameter “State of Auto.operation after startup”

This parameter is for setting whether to enable state of Auto.operation after startup the device. Options:

**Disable**

**Enable**

**Fan speed output setting**

## Parameter “Data type of fan speed”

This parameter is for setting the data type of fan speed. Options:

**1bit**

**1byte**

## Parameter “Object datatype of 1byte fan speed”

This parameter is visible when “1byte” is selected. Set the object datatype of 1byte fan speed. Options:

**Fan stage (DPT 5.100)**

**Percentage (DPT 5.001)**

## Parameter “Output value for fan speed low/medium/high”

This parameter is visible when “1byte” is selected. Set the value sent for each fan speed switchover. Fan speed off when value is 0. Options according to fan object datatype: **1..255 /1..100**

**Note: the out value and status value must meet the condition low<medium<high, if not, they can not be configured on ETS, and display red box warning, as shown as follow:**

Output value for Fan speed low	<input type="text" value="68"/>	%
Output value for Fan speed medium	<input type="text" value="67"/>	%
Output value for Fan speed high	<input type="text" value="100"/>	%

#### Parameter "Object value of fan speed off/low/medium/high"

This parameter is visible when 1bit" is selected. Set the value sent for each fan speed, sent by three 1 bit objects at the same time. Options:

**Low=0,Medium=0,High=0**

**Low=1,Medium=0,High=0**

**Low=0,Medium=1,High=0**

**Low=1,Medium=1,High=0**

**Low=0,Medium=0,High=1**

**Low=1,Medium=0,High=1**

**Low=0,Medium=1,High=1**

**Low=1,Medium=1,High=1**

#### Parameter "Delay between fan speed switch [0..100]"\* 50ms"

This parameter is visible when 1bit" is selected. Set the delay time between fan speed switchover, and consider it according to the fan technical characters. Options: **0..100**

Turn off fan speed before switch the fan speed, and turn on it after the delay time. When delay time is set as 0, it will not turn off first then turn on, but switch to next fan speed directly.

## Fan speed control setting

#### Parameter "Control value reference from"

This parameter is for setting the reference of control value under automatic operation. Options:

**PM2.5**

**CO2**

**VOC**

#### Parameter "Object datatype of PM2.5/VOC"

These parameters are for setting the datatype of PM2.5/VOC. Datatype determines object type, select it according to the docking PM2.5 or VOC sensor data type. Options:

**Value in ug/m3(DPT 7.001)**

**Float value in ug/m3(DPT 9.030)**

DPT\_7.001: Suitable for integrated value.

DPT\_9.030: Suitable for float value.

#### Parameter "Object datatype of CO2"

This parameter is for setting the datatype of CO2. Datatype determines object type, select it according to the docking CO2 sensor data type. Options:

**Value in ppm(DPT 7.001)**

**Float value in ppm(DPT 9.008)**

DPT\_7.001: Suitable for integrated value.

DPT\_9.008: Suitable for float value.

#### Parameter "Time period for request control value [0..255]min"

This parameter is for setting the time period for device to send a control value read request to external sensor after bus recovery or finish programming (**After stabilization time 2min, then read**). Options: **0..255**

#### Parameter "The fan speed status when the control value error"

This parameter is for setting the default fan speed of ventilation system when control value is error. Options:

**Off**

**Low**

**Medium**

**High**

#### Parameter "Threshold value speed OFF<->low [1..999]/ [1..4000]"

Define threshold value for off-fan and low-level fan speeds, options: **1..999/1..4000**

If the control value is greater than or equal to this setting threshold value, low-level fan speed will start running; if the control value is less than this setting threshold value, the fan will be turned off.

#### Parameter "Threshold value speed low<->medium [1..999]/ [1..4000]"

Define the threshold value for switching the fan speed to medium fan speed, if the control value is greater than or equal to this setting threshold, the medium fan speed will start running. Options: **1..999/1..4000**

#### Parameter "Threshold value speed medium<->high [1..999]/ [1..4000]"

Define the threshold for switching the fan speed to high fan speed, if the control value is greater than or equal to this setting threshold, the high fan speed will start running. Options: **1..999/1..4000**

**Tip: The controller evaluates the threshold in ascending order.**

**First check → OFF <-> low fan speed threshold → low fan speed <-> medium fan speed → medium fan speed <-> high fan speed.**

**The correctness of functional execution is guaranteed only in this case:**

**The threshold of OFF <-> low fan speed is lower than that of low fan speed <-> medium fan speed, and the threshold of low fan speed <-> medium fan speed is lower than that of medium fan speed <-> high fan speed.**

**Parameter "Hysteresis threshold value in +/- [10...30]/[100..400]"**

This parameter is for setting the hysteresis value of the threshold value, which can avoid the unnecessary action of the fan when the control value fluctuates near the threshold. Options: **10..30/100..400**

For example, the control type is CO2, the Hysteresis value is 100 and the threshold is 450, then the upper limit threshold 550 (Threshold value+Hysteresis value) and the lower limit threshold 350 (Threshold value-Hysteresis value). When the control value is between 350 ~550, fan action will not be caused, and the previous status will still be maintained. Only less than 350 or greater than or equal to 550 will change the running status of the fan. As shown in the following figure:

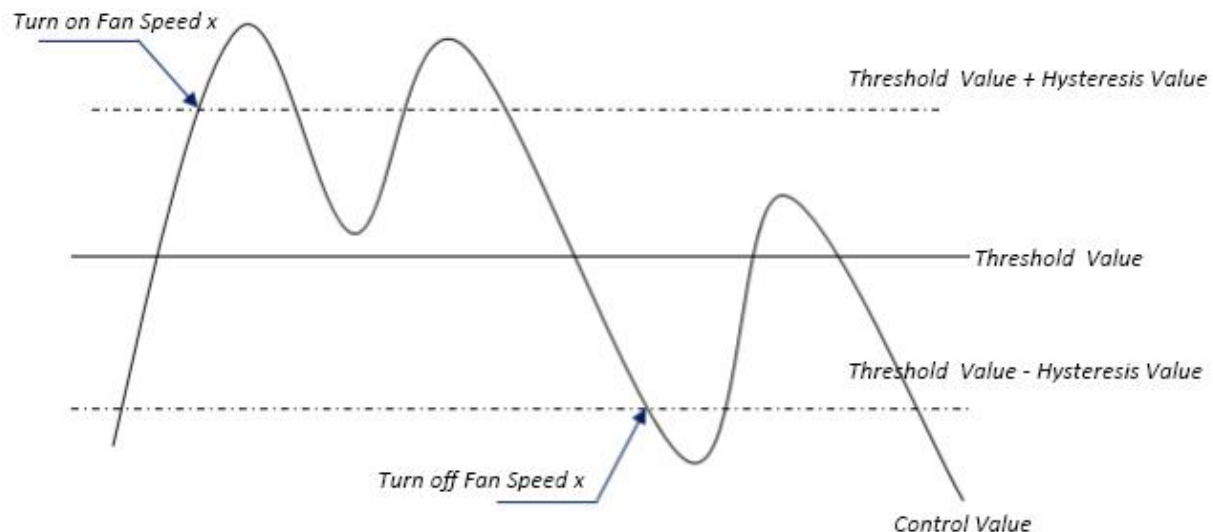

**Note:**

**When hysteresis is enabled, if the threshold overlap occurs, fan action is specified as follows:**

- 1) Hysteresis determines the control point where Fan speed conversion occurs;**
- 2) If Fan speed conversion occurs, new fan speed is determined by control value and threshold value,**

irrespective of hysteresis.

For example (1):

Take PM2.5 as an example

OFF <-> Low fan speed threshold value is 35

Low fan speed <-> Medium fan speed threshold value is 55

Medium fan speed <-> High fan speed threshold value is 75

Hysteresis value is 25

The fan speed of the fan turbine increases from OFF:

Fan OFF status will change at a control value of 60 ( $\geq 25+35$ ), and new fan speed will be the mid-fan speed (because 60 is between 55 and 75, irrespective of hysteresis at this time), so the low fan speed is ignored;

The behavior of fan speed when descending from a high fan speed:

The high fan speed will change at a control value of 50 ( $< 75-25$ ), and new fan speed will be low fan speed (because 50 is between 35 and 55, irrespective of hysteresis), so the fan speed is ignored.

For example(2):

Take PM2.5 as an example

OFF <-> Low fan speed threshold value is 20

Low fan speed <-> Medium fan speed threshold value is 40

Medium fan speed <-> High fan speed threshold value is 70

Hysteresis value is 10

When fan speed is increasing from OFF:

The OFF status will be turned when the control value is 30 ( $\geq 20+10$ )

When the control value 41 is received, the new speed will be at medium (because the hysteresis is ignored when the value 41 is between 40 and 70), therefore the low speed is ignored.

When the control value 39 is received, the new speed will be at low (because the hysteresis is ignored when the value 39 is between 20 and 40)

When Fan Speed decreasing from high:

The high speed will be turned when the control value is 60 ( $< 70-10$ )

---

When the control value 39 is received, the new speed will be at low(because the hysteresis is ignored when the value 39 is between 20 and 40),therefore the medium speed is ignored.

3) When the control value is 0,the fan will be off at any circumstances.

#### Parameter "Minimum time in fan speed {0..65535}s"

Defines the residence time of the fan from the current fan speed to a higher fan speed or lower fan speed, that is, the minimum time for a fan speed operation. Options: **0..65535**

If you need to switch to another fan speed, you need to wait for this period of time before switching.

If the current fan speed has been running long enough, the fan speed can be changed quickly.

0: there is no minimum running time, but the delay switching time of fan speed still needs to be considered.

**Note: The residence time for this parameter setting is only enabled in Auto mode.**

## 5.6. Parameter window “Logic”

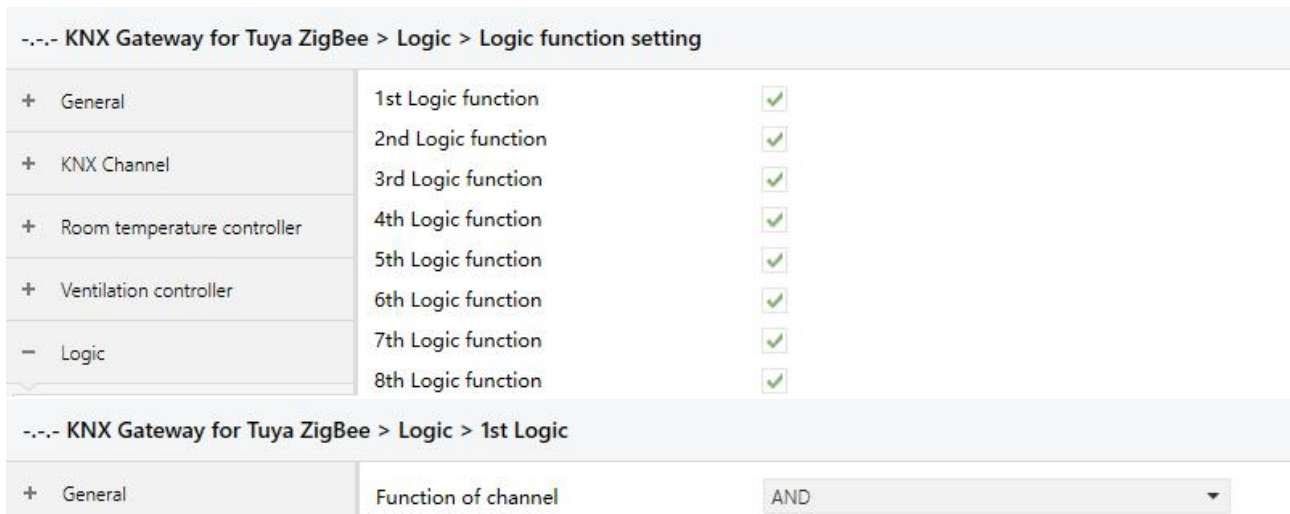

Fig.5.6 “Logic function setting” Parameter window

### Parameter “1st/2nd/3rd... Logic function”

This parameter is for setting the setting interface of logic function, display corresponding logic function page when select. Up to enable 8 logic functions.

### Parameter “Function of channel”

This parameter is for setting the logic function of the channel. Options:

**AND**

**OR**

**XOR**

**Gate forwarding**

**Threshold comparator**

**Format convert**

**Gate function**

**Delay function**

**Staircase lighting**

AND/OR/XOR: as the parameter is similar to the communication object (only the logic algorithm is different), the following parameters taking one options for example.



### 5.6.1. Parameter window “AND/OR/XOR”

--- KNX Gateway for Tuya ZigBee > Logic > 1st Logic

+ General	Function of channel	AND
+ KNX Channel	Input a	Disconnected
+ Room temperature controller	Default value	<input checked="" type="radio"/> 0 <input type="radio"/> 1
+ Ventilation controller	Input b	Disconnected
	Default value	<input checked="" type="radio"/> 0 <input type="radio"/> 1
- Logic	Input c	Disconnected
Logic function setting	Default value	<input checked="" type="radio"/> 0 <input type="radio"/> 1
1st Logic	Input d	Disconnected
2nd Logic	Default value	<input checked="" type="radio"/> 0 <input type="radio"/> 1
3rd Logic	Input e	Disconnected
4th Logic	Default value	<input checked="" type="radio"/> 0 <input type="radio"/> 1
5th Logic	Input f	Disconnected
6th Logic	Default value	<input checked="" type="radio"/> 0 <input type="radio"/> 1
7th Logic	Input g	Disconnected
8th Logic	Default value	<input checked="" type="radio"/> 0 <input type="radio"/> 1
	Input h	Disconnected
	Default value	<input checked="" type="radio"/> 0 <input type="radio"/> 1
	Result is inverted	<input checked="" type="radio"/> No <input type="radio"/> Yes
	Read input object value after bus voltage recovery	<input checked="" type="radio"/> No <input type="radio"/> Yes
	Output send when	<input checked="" type="radio"/> Receiving a new telegram <input type="radio"/> Every change of output object
	Send delay time: Base	None
	Factor: 1..255	1

Fig.5.6.1 “AND/OR/XOR” parameter window

#### Parameter “Input a/b/c/d/e/f/g/h”

This parameter is for setting whether input x to calculate, whether to normally calculate or inverted calculate. Options:

**Disconnected**

**Normal**

**Inverted**

Disconnected: not to calculate;

Normal: to directly calculate the input value;

Inverted: invert the input value, then to calculate. **Note: not to invert the initiate value.**

#### Parameter "Default value"

This parameter is for setting the initial value of logic input x. Options:

**0**

**1**

#### Parameter "Result is inverted"

This parameter is for setting whether to invert the logic calculation result. Options:

**No**

**Yes**

No: output directly;

Yes: output after inverting.

#### Parameter "Read input object value after bus voltage recovery"

This parameter is for setting whether to send the read request to the logic input object after device voltage recovery or finish programming. Options:

**No**

**Yes**

#### Parameter "Output send when"

This parameter is for setting the condition of sending logic result. Options:

**Receiving a new telegram**

**Every change of output object**

Receiving a new telegram: every time the object received a new input value will the logic result be sent to the bus;

Every change of output object: only when logic result has changed will it be sent to the bus.

**Tip: when in the first time to logic calculate, the logic result will be sent even if it has no change.**

#### Parameter "Send delay time"

**Base:**            **None**

**0.1s**

**1s**

...

**10s**

**25s**

**Factor: 1..255**

This parameter is for setting the delay time for sending the logic calculation result to the bus. Delay time = Base × Factor, if option “None” of Base is selected, then there is no delay.

### 5.6.2. Parameter window “Gate forwarding”

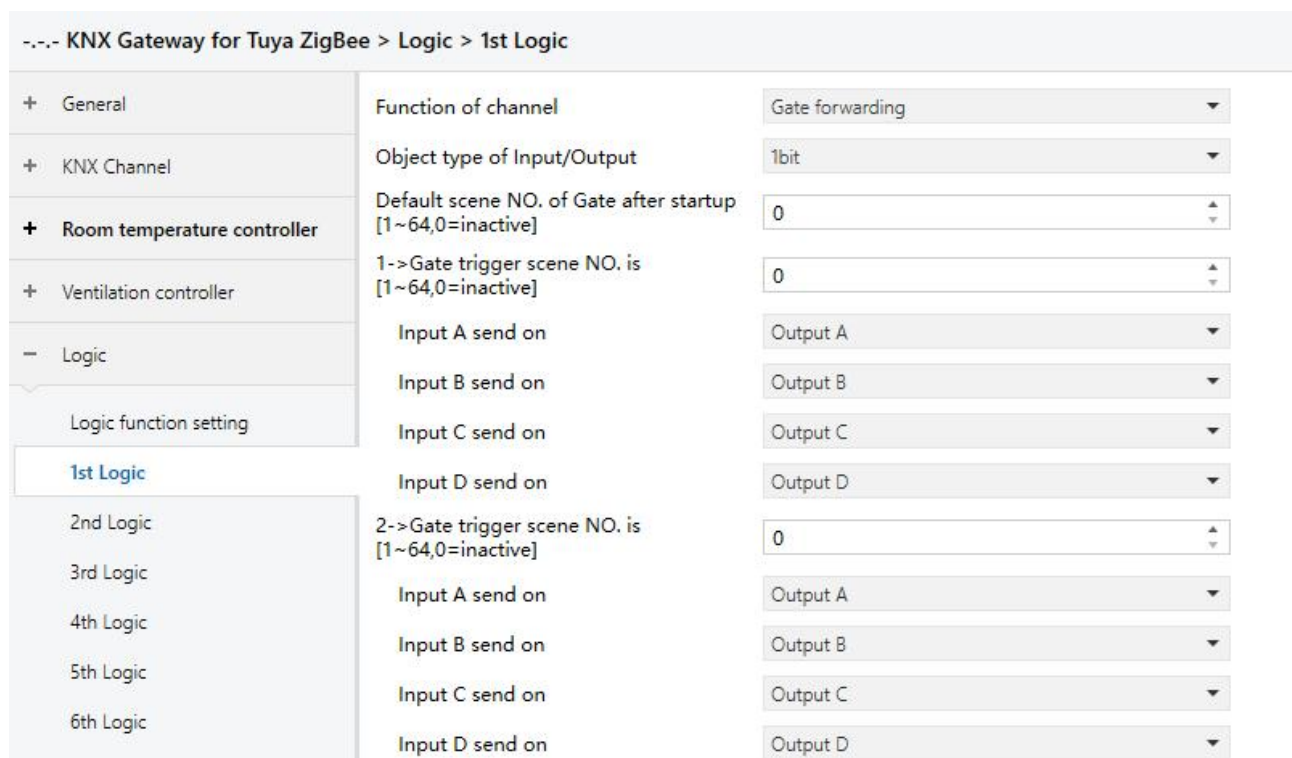

Fig.5.6.2 “Gate forwarding” parameter window

#### Parameter “Object type of Input/Output”

This parameter is for setting the object type of input/output. Options:

**1bit**

**4bit**

**1byte**

#### Parameter “Default scene NO. of Gate after startup [1~64,0=inactive]”

This parameter is for setting the initial scene where logical gate forwarding can be performed by default after device starts, which needs to be configured in the parameters. Options: **1..64, 0=inactive**

**Note: gate scene is recommended to be selected before operating, or it will enable the initiate scene by default.**

Parameter "z->Gate trigger scene NO. is [1-64,0=inactive]" (z=1-8)

This parameter is for setting scene number of logic gate forwarding. Up to 8 trigger scene number can be set for each logic. Options: **1..64, 0=inactive**

Parameter "Input A/B/C/D send on"

This parameter is for setting the output of input X (X=A/B/C/D) after gate forwarding. Options:

**Output A**

**Output B**

...

**Output B,C,D**

According to the options, one input can be forwarded into one or more outputs, the output value is the same as the input value.

### 5.6.3. Parameter window "Threshold comparator"

--- KNX Gateway for Tuya ZigBee > Logic > 1st Logic

+	General	Function of channel	Threshold comparator
+	KNX Channel	Threshold value data type	1byte
+	Room temperature controller	Threshold value 0..255	0
+	Ventilation controller	If Object value < Threshold value	Do not send telegram
		If Object value = Threshold value	Do not send telegram
-	Logic	If Object value != Threshold value	Do not send telegram
	Logic function setting	If Object value > Threshold value	Do not send telegram
	<b>1st Logic</b>	If Object value <= Threshold value	Do not send telegram
	2nd Logic	If Object value >= Threshold value	Do not send telegram
	3rd Logic	Output send when	<input checked="" type="radio"/> Receiving a new telegram <input type="radio"/> Every change of output object
	4th Logic	Send delay time: Base	None
	5th Logic	Factor: 1..255	1

Fig.5.6.3 "Threshold comparator" parameter window

## Parameter “Threshold value data type”

This parameter is for setting the threshold value data type. Options:

**4bit**

**1byte**

**2byte**

**4byte**

## Parameter “Threshold value 0..255”

This parameter is for setting threshold value, the range depends on the data type. Options: **4bit 0..15/1byte 0..255/ 2byte 0..65535 /4byte 0..4294967295**

## Parameter “If Object value&lt;Threshold value”

**Parameter “If Object value!=Threshold value”**

**Parameter “If Object value<Threshold value”**

**Parameter “If Object value<Threshold value”**

**Parameter “If Object value<Threshold value”**

This parameter is for setting the logic result value that should be sent when threshold value Less than, equal to, not equal to, greater than, less than or equal to the setting valve. Options:

**Do not send telegram**

**Send value "0"**

**Send value "1"**

Do not send telegram: not consider to select this option;

Send value “0”/“1””: when condition is satisfied, send telegram 0 or1.

If there is a conflict between the setting options between parameters, the base on the value that should be sent when reach the final parameter condition. **For example: parameter “If Object value=Threshold value” is set to be “Send value “0” ”; parameter “If Object value<=Threshold value” is set to be “Send value “1” ”; when object value is equal to the threshold value, then the logic result will send “1”.**

## Parameter “Output send when”

This parameter is for setting the condition of sending logic result. Options:

**Receiving a new telegram**

**Every change of output object**

Receiving a new telegram: every time the object received a new input value will the logic result be sent to the bus;

Every change of output object: only when logic result has changed will it be sent to the bus.

**Tip: when in the first time to logic algorithm, the logic result will be sent even if it has no change.**

Parameter "Send delay time"

- Base:**           None
- 0.1s
- 1s
- ...
- 10s
- 25s
- Factor:**       1..255

This parameter is for setting the delay time for sending the logic algorithm result to the bus. Delay time = Base x Factor, if option "None" of Base is selected, then there is no delay.

**5.6.4. Parameter window "Format convert"**

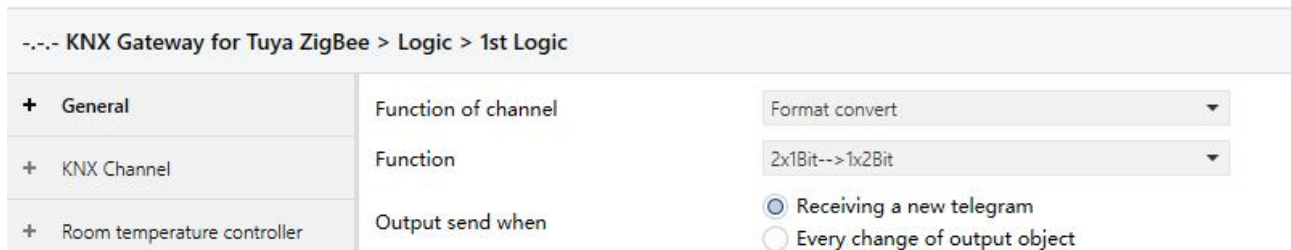

Fig.5.6.4 "Format convert" parameter window

Parameter "Function"

This parameter is for setting the format convert type. Options:

- 2x1bit-->1x2bit
- 8x1bit-->1x1byte
- 1x1byte-->1x2byte
- 2x1byte-->1x2byte
- 2x2byte-->1x4byte
- 1x1byte-->8x1bit
- 1x2byte-->2x1byte

1x4byte-->2x2byte

1x3byte-->3x1byte

3x1byte-->1x3byte

#### Parameter “Output send when”

This parameter is for setting the condition of sending logic result. Options:

**Receiving a new telegram**

**Every change of output object**

Receiving a new telegram: every time the object received a new input value will the logic result be sent to the bus;

Every change of output object: only when logic result has changed will it be sent to the bus.

**Tip: when in the first time to logic algorithm, the logic result will be sent even if it has no change.**

#### 5.6.5. Parameter window “Gate function”

Fig.5.6.5 “Gate function” parameter window

#### Parameter “Object type of Input/Output”

This parameter is for setting the object type of input/output. Options:

**1bit[On/Off]**

**1byte[0..100%]**

**1byte[0..255]**

**2byte[Float]**

**2byte[0..65535]**



**Parameter "Filter function"**

This parameter is visible when "1bit[On/Off]" is selected. Set whether to filter On or Off telegram, only pass one of them or pass all. Options:

**Deactivate**

**On filter out**

**Off filter out**

Deactivate: Do not filter the On or Off telegrams;

On filter out: Off can pass, On cannot pass;

Off filter out: On can pass, Off cannot pass.

**Parameter "Value output"**

This parameter is visible when "1bit[On/Off]" is selected. Set whether to invert the value then output it. Options:

**Normal**

**Inverted**

**Parameter "Gate object value"**

This parameter is for setting whether to invert the gate object value then output it. Options:

**Normal**

**Inverted**

**Parameter "Gate status after power on"**

This parameter is for setting the gate status after power on. Options:

**Disable**

**Enable**

**Parameter "Save input signal when gate close"**

This parameter is for setting whether to save input signal on gate close. Options:

**No**

**Yes**

No: disable to save the input, the input values received during the gate closing period are ignored;

Yes: enable to save the input, the input values received during the gate closing period are output when gate is open (whether the input value is changed or not).

### 5.6.6. Parameter window “Delay function”

--- KNX Gateway for Tuya ZigBee > Logic > 1st Logic

+ General	Function of channel	Delay function
+ KNX Channel	Object type of Input/Output	1bit[On/Off]
+ Room temperature controller	Delay time [0..6500]	10 s

Fig.5.6.6 “Delay function” parameter window

#### Parameter “Object type of Input/Output”

This parameter is for setting the object type of input/output. Options:

**1bit[On/Off]**

**1byte[0..100%]**

**1byte[0..255]**

**2byte[Float]**

**2byte[0..65535]**

#### Parameter “Delay time [0..6500]s”

This parameter is for setting the delay time that output object forwards the value when the input object receives the telegram. Options: **0..6500**

**Note: Receive telegram again in delay time, re-timing.**

### 5.6.7. Parameter window “Staircase lighting”

--- KNX Gateway for Tuya ZigBee > Logic > 1st Logic

+ General	Function of channel	Staircase lighting
+ KNX Channel	Trigger value	1
+ Room temperature controller	Object type of output	<input checked="" type="radio"/> 1bit <input type="radio"/> 1byte
+ Ventilation controller	Duration time of staircase lighting [10..6500]	10 s
- Logic	Send value 1 when trigger	<input type="radio"/> OFF <input checked="" type="radio"/> ON
Logic function setting	Send value 2 after duration time	<input checked="" type="radio"/> OFF <input type="radio"/> ON
	Retriggering	<input type="radio"/> Disable <input checked="" type="radio"/> Enable

Fig.5.6.7 “Staircase lighting” parameter window

**Parameter “Trigger value”**

This parameter is for setting the telegram value of the object “Trigger value”. Options:

**0**

**1**

**0 or 1**

**Parameter “Object type of output”**

This parameter is for setting the object type of output. Options:

**1bit**

**1byte**

**Parameter “Duration time of staircase lighting[10..6500]s”**

This parameter is for setting duration time of staircase lighting after the stair light power on.

Options: **10..6500**

**—Parameter “Send value 1 when trigger”****—Parameter “Send value 2 after duration time”**

These parameters are for setting the value to send. Send value 1 when trigger, and then send value 2 after duration time. Options display according to the output object datatype.

When 1 bit, options:

**OFF**

**ON**

When 1 byte , options: **0..255**

**Parameter “Retriggering”**

This parameter is for setting whether to trigger re-timing when received trigger value in delay time. Options:

**Disable**

**Enable**

## Chapter 6 Description of Communication Object

The communication object is the medium to communicate other device on the bus, namely only the communication object can communicate with the bus.

**NOTE:** “C” in “Flag” column in the below table means enable the communication function of the object; “W” means value of object can be written from the bus; “R” means the value of the object can be read by the other devices; “T” means the object has the transmission function; “U” means the value of the object can be updated.

### 6.1. “General” Communication Object

Number	Name	Object Function	Description	Group Address	Length	C	R	W	T	U	Data Type	Priority
1	General	In operation			1 bit	C	R	-	T	-	switch	Low

Fig.6.1 “General” Communication Object

NO.	Object Function	Name	Data Type	Flag	DPT
1	In operation	General	1bit	C,R,T	1.001 switch

The communication object is used to periodically send a telegram “1” to the bus to indicate that the device is working properly.

Table 6.1 “General” communication object table

### 6.2. “KNX Channel” Communication Object

Numb	Name	Object Function	Description	Group Address	Length	C	R	W	T	U	Data Type	Priority
300	KNX General	Device online common 1, status			1 bit	C	-	W	T	U	switch	Low
301	KNX General	Device online common 2, status			1 bit	C	-	W	T	U	switch	Low
302	KNX General	Device online common 3, status			1 bit	C	-	W	T	U	switch	Low
303	KNX General	Device online common 4, status			1 bit	C	-	W	T	U	switch	Low
304	KNX General	Device online common 5, status			1 bit	C	-	W	T	U	switch	Low
305	KNX General	Device online common 6, status			1 bit	C	-	W	T	U	switch	Low
306	KNX General	Device online common 7, status			1 bit	C	-	W	T	U	switch	Low
307	KNX General	Device online common 8, status			1 bit	C	-	W	T	U	switch	Low
308	KNX General	Device online common 9, status			1 bit	C	-	W	T	U	switch	Low
309	KNX General	Device online common 10, status			1 bit	C	-	W	T	U	switch	Low
310	KNX: Channel 1	Device online, status			1 bit	C	-	W	T	U	switch	Low

Fig.6.2 KNX general communication Object

NO.	Object Function	Name	Data Type	Flag	DPT
300/.../309	Device online common x, status	KNX General	1bit	C,W,T,U	1.001 switch

The communication object is used to send the request to the bus, for common device to query the KNX device online status, and also can receive the feedback. Telegrams:

0—Offline

1—Online

Suitable for devices with multiple circuits. For example, multiple channels of gateway may be multiple circuits that control the same KNX device, so each channel can share one request.

<b>310</b>	<b>Device online, status</b>	<b>KNX: {{Channel 1}}</b>	<b>1bit</b>	<b>C,W,T,U</b>	<b>1.001 switch</b>
------------	------------------------------	---------------------------	-------------	----------------	---------------------

The communication object is used to send the request to the bus, for independent device to query the KNX device online status, and also can receive the feedback. Telegrams:

0—Offline

1—Online

Suitable for a device that only controlled by the single channel of gateway.

The name in parentheses changes with the parameter “Description (max 30 char.)”. If description is empty, display “...Channel x” by default. The same below.

Table 6.2 KNX general communication object table

### 6.2.1. Communication Object of basic function

Numb	Name	Object Function	Description	Group Address	Length	C	R	W	T	U	Data Type	Priority
311	KNX: Channel 1	Switch			1 bit	C	-	-	T	-	switch	Low
312	KNX: Channel 1	Switch, status			1 bit	C	-	W	T	U	switch	Low
<b>Switch</b>												
Numb	Name	Object Function	Description	Group Address	Length	C	R	W	T	U	Data Type	Priority
311	KNX: Channel 1	Switch			1 bit	C	-	-	T	-	switch	Low
312	KNX: Channel 1	Brightness dimming			1 byte	C	-	-	T	-	percentage (0..100%)	Low
313	KNX: Channel 1	Brightness, status			1 byte	C	-	W	T	U	percentage (0..100%)	Low
<b>Switch/Dimming</b>												
Numb	Name	Object Function	Description	Group Address	Length	C	R	W	T	U	Data Type	Priority
311	KNX: Channel 1	Switch			1 bit	C	-	-	T	-	switch	Low
312	KNX: Channel 1	Switch, status			1 bit	C	-	W	T	U	switch	Low
313	KNX: Channel 1	RGB dimming value			3 bytes	C	-	-	T	-	RGB value 3x(0..255)	Low
317	KNX: Channel 1	RGB brightness, status			3 bytes	C	-	W	T	U	RGB value 3x(0..255)	Low
313	KNX: Channel 1	Red dimming value			1 byte	C	-	-	T	-	percentage (0..100%)	Low
314	KNX: Channel 1	Green dimming value			1 byte	C	-	-	T	-	percentage (0..100%)	Low
315	KNX: Channel 1	Blue dimming value			1 byte	C	-	-	T	-	percentage (0..100%)	Low
317	KNX: Channel 1	Red brightness, status			1 byte	C	-	W	T	U	percentage (0..100%)	Low
318	KNX: Channel 1	Green brightness, status			1 byte	C	-	W	T	U	percentage (0..100%)	Low
319	KNX: Channel 1	Blue brightness, status			1 byte	C	-	W	T	U	percentage (0..100%)	Low
<b>RGB dimming</b>												
Numb	Name	Object Function	Description	Group Address	Length	C	R	W	T	U	Data Type	Priority
311	KNX: Channel 1	Switch			1 bit	C	-	-	T	-	switch	Low
312	KNX: Channel 1	Switch, status			1 bit	C	-	W	T	U	switch	Low
313	KNX: Channel 1	RGBW dimming value			6 bytes	C	-	-	T	-	RGBW value 4x(0..100%)	Low
317	KNX: Channel 1	RGBW brightness, status			6 bytes	C	-	W	T	U	RGBW value 4x(0..100%)	Low

RGBW dimming(1)



Num	Name	Object Function	Description	Group Address	Length	C	R	W	T	U	Data Type	Priority
313	KNX: Channel 1	Red dimming value			1 byte	C	-	-	T	-	percentage (0..100%)	Low
314	KNX: Channel 1	Green dimming value			1 byte	C	-	-	T	-	percentage (0..100%)	Low
315	KNX: Channel 1	Blue dimming value			1 byte	C	-	-	T	-	percentage (0..100%)	Low
316	KNX: Channel 1	White dimming value			1 byte	C	-	-	T	-	percentage (0..100%)	Low
317	KNX: Channel 1	Red brightness, status			1 byte	C	-	W	T	U	percentage (0..100%)	Low
318	KNX: Channel 1	Green brightness, status			1 byte	C	-	W	T	U	percentage (0..100%)	Low
319	KNX: Channel 1	Blue brightness, status			1 byte	C	-	W	T	U	percentage (0..100%)	Low
320	KNX: Channel 1	White brightness, status			1 byte	C	-	W	T	U	percentage (0..100%)	Low

RGBW dimming(2)

Num	Name	Object Function	Description	Group Address	Length	C	R	W	T	U	Data Type	Priority
311	KNX: Channel 1	Switch			1 bit	C	-	-	T	-	switch	Low
312	KNX: Channel 1	Switch, status			1 bit	C	-	W	T	U	switch	Low
313	KNX: Channel 1	Color temperature value			2 bytes	C	-	-	T	-	absolute colour temperature (K)	Low
314	KNX: Channel 1	Brightness value			1 byte	C	-	-	T	-	percentage (0..100%)	Low
317	KNX: Channel 1	Color temperature, status			2 bytes	C	-	W	T	U	absolute colour temperature (K)	Low
318	KNX: Channel 1	Brightness, status			1 byte	C	-	W	T	U	percentage (0..100%)	Low

Color temperature

Num	Name	Object Function	Description	Group Address	Length	C	R	W	T	U	Data Type	Priority
311	KNX: Channel 1	Open/Close			1 bit	C	-	-	T	-	open/close	Low
312	KNX: Channel 1	Stop			1 bit	C	-	-	T	-	step	Low

Curtain step/move

Num	Name	Object Function	Description	Group Address	Length	C	R	W	T	U	Data Type	Priority
311	KNX: Channel 1	Up/Down			1 bit	C	-	-	T	-	up/down	Low
312	KNX: Channel 1	Stop			1 bit	C	-	-	T	-	step	Low

Roller blind step/move

Num	Name	Object Function	Description	Group Address	Length	C	R	W	T	U	Data Type	Priority
311	KNX: Channel 1	Open/Close			1 bit	C	-	-	T	-	open/close	Low
312	KNX: Channel 1	Stop			1 bit	C	-	-	T	-	step	Low
313	KNX: Channel 1	Blind position			1 byte	C	-	-	T	-	percentage (0..100%)	Low
315	KNX: Channel 1	Blind position, status			1 byte	C	-	W	T	U	percentage (0..100%)	Low

Curtain position

Num	Name	Object Function	Description	Group Address	Length	C	R	W	T	U	Data Type	Priority
311	KNX: Channel 1	Up/Down			1 bit	C	-	-	T	-	up/down	Low
312	KNX: Channel 1	Stop			1 bit	C	-	-	T	-	step	Low
313	KNX: Channel 1	Blind position			1 byte	C	-	-	T	-	percentage (0..100%)	Low
315	KNX: Channel 1	Blind position, status			1 byte	C	-	W	T	U	percentage (0..100%)	Low

Roller blind position

Num	Name	Object Function	Description	Group Address	Length	C	R	W	T	U	Data Type	Priority
311	KNX: Channel 1	Up/Down			1 bit	C	-	-	T	-	open/close	Low
312	KNX: Channel 1	Stop/Slat adj.			1 bit	C	-	-	T	-	step	Low
313	KNX: Channel 1	Blind position			1 byte	C	-	-	T	-	percentage (0..100%)	Low
314	KNX: Channel 1	Slat position			1 byte	C	-	-	T	-	percentage (0..100%)	Low
315	KNX: Channel 1	Blind position, status			1 byte	C	-	W	T	U	percentage (0..100%)	Low
316	KNX: Channel 1	Slat position, status			1 byte	C	-	W	T	U	percentage (0..100%)	Low

Venetian blind position and slat

Num	Name	Object Function	Description	Group Address	Length	C	R	W	T	U	Data Type	Priority
311	KNX: Channel 1	Send 1bit value			1 bit	C	-	-	T	-	switch	Low
311	KNX: Channel 1	Send 2bit value			2 bit	C	-	-	T	-	switch control	Low
311	KNX: Channel 1	Send 1byte percent value			1 byte	C	-	-	T	-	percentage (0..100%)	Low
311	KNX: Channel 1	Send 1byte unsigned value			1 byte	C	-	-	T	-	counter pulses (0..255)	Low
311	KNX: Channel 1	Recall scene No.			1 byte	C	-	-	T	-	scene number	Low
311	KNX: Channel 1	Send 2byte float value			2 bytes	C	-	-	T	-	2-byte float value	Low
311	KNX: Channel 1	Send 2byte unsigned value			2 bytes	C	-	-	T	-	pulses	Low

Value sender

Num	Name	Object Function	Description	Group Address	Length	C	R	W	T	U	Data Type	Priority
311	KNX: Channel 1	Trigger scene No.			1 byte	C	-	W	-	-	scene number	Low

Scene switch

Fig.6.2.1 Basic function communication object

NO.	Object Function	Name	Data Type	Flag	DPT
311	Switch	KNX: {{Channel 1}}	1bit	C,T	1.001 switch
312	Switch, status	KNX: {{Channel 1}}	1bit	C,W,T,U	1.001 switch
<p>These two communication objects apply to switch, dimming, color and color temperature control. Telegrams:</p> <p style="padding-left: 40px;">0——Turn off the light</p> <p style="padding-left: 40px;">1——Turn on the light</p> <p>Obj.311: Used for sending On/Off telegrams to the bus, to control the light on/off.</p> <p>Obj.312: Used for receiving On/Off status responded from other bus devices, such as dimming actuator, switch actuator.</p>					
312	Brightness dimming	KNX: {{Channel 1}}	1byte	C,T	5.001 percentage(0..100%)
313	Brightness, status	KNX: {{Channel 1}}	1byte	C,W,T,U	5.001 percentage(0..100%)
<p>These two communication objects apply to brightness dimming. Telegrams: 0~100%</p> <p>Obj.312: Used for sending dimming telegrams to the bus, that is, sending the brightness value.</p> <p>Obj.313: Used for receiving brightness status responded from dimming actuator.</p>					
313	Red dimming value	KNX: {{Channel 1}}	1byte	C,T	5.001 percentage(0..100%)
317	Red brightness, status	KNX: {{Channel 1}}	1byte	C,W,T,U	5.001 percentage(0..100%)
<p>These two communication objects are visible when 3x1byte for the RGB object type or 4x1byte for the RGBW object type is selected. Apply to control brightness of multi-color lamp, and also support color temperature adjustment. Telegrams: 0...100%</p> <p>Obj.313 Used for sending brightness value of the control R (red) channel to the bus.</p> <p>Obj.317: Used for receiving brightness value of the control R (red) channel from bus.</p>					
314	Green dimming value	KNX: {{Channel 1}}	1byte	C,T	5.001 percentage(0..100%)
318	Green brightness, status	KNX: {{Channel 1}}	1byte	C,W,T,U	5.001 percentage(0..100%)
<p>These two communication objects are visible when 3x1byte for the RGB object type or 4x1byte for the RGBW object type is selected. Apply to control brightness of multi-color lamp, and also support color temperature adjustment. Telegrams: 0...100%</p> <p>Obj.314: Used for sending brightness value of the control G (green) channel to the bus.</p> <p>Obj.318: Used for receiving brightness value of the control G (green) channel from bus.</p>					

315	Blue dimming value	KNX: {{Channel 1}}	1byte	C,T	5.001 percentage(0..100%)									
319	Blue brightness, status	KNX: {{Channel 1}}	1byte	C,W,T,U	5.001 percentage(0..100%)									
<p>These two communication objects are visible when 3x1byte for the RGB object type or 4x1byte for the RGBW object type is selected. Apply to control brightness of multi-color lamp, and also support color temperature adjustment. Telegrams: 0...100%</p> <p>Obj.315: Used for sending brightness value of the control B (blue) channel to the bus.</p> <p>Obj.319: Used for receiving brightness value of the control B (blue) channel from bus.</p>														
316	White dimming value	KNX: {{Channel 1}}	1byte	C,T	5.001 percentage(0..100%)									
320	White brightness, status	KNX: {{Channel 1}}	1byte	C,W,T,U	5.001 percentage(0..100%)									
<p>These two communication objects are visible when 4x1byte for the RGBW object type is selected. Apply to control brightness of multi-color lamp, and also support color temperature adjustment. Telegrams: 0...100%</p> <p>Obj.316: Used for sending brightness value of the control W (white) channel to the bus.</p> <p>Obj.320: Used for receiving brightness value of the control W (white) channel from bus.</p>														
313	RGB dimming value	KNX: {{Channel 1}}	3byte	C,T	232.600 RGB value 3x(0..255)									
317	RGB brightness, status	KNX: {{Channel 1}}	3byte	C,W,T,U	232.600 RGB value 3x(0..255)									
<p>These two communication objects are visible when 1x3byte for the RGB object type is selected. Apply to control brightness of multi-color lamp, and also support color temperature adjustment.</p> <p>Obj.313: Used for sending brightness value of RGB three-color lamp to the bus.</p> <p>Obj.317: Used for receiving brightness value of RGB three-color lamp from bus.</p> <p>3-Byte Code for RGB Dimming Object Data Type: U8 U8 U8, as follows:</p> <table border="1" style="margin-left: auto; margin-right: auto;"> <tr> <td style="text-align: center;">3<sub>MSB</sub></td> <td style="text-align: center;">2</td> <td style="text-align: center;">1<sub>LSB</sub></td> </tr> <tr> <td style="text-align: center;">R</td> <td style="text-align: center;">G</td> <td style="text-align: center;">B</td> </tr> <tr> <td style="text-align: center;">UUUUUUUU</td> <td style="text-align: center;">UUUUUUUU</td> <td style="text-align: center;">UUUUUUUU</td> </tr> </table> <p>R: red dimming value; G: green dimming value; B: blue dimming value.</p>						3 <sub>MSB</sub>	2	1 <sub>LSB</sub>	R	G	B	UUUUUUUU	UUUUUUUU	UUUUUUUU
3 <sub>MSB</sub>	2	1 <sub>LSB</sub>												
R	G	B												
UUUUUUUU	UUUUUUUU	UUUUUUUU												
313	RGBW dimming value	KNX: {{Channel 1}}	6byte	C,T	251.600 DPT_Colour_RGBW									
317	RGBW brightness, status	KNX: {{Channel 1}}	6byte	C,W,T,U	251.600 DPT_Colour_RGBW									
<p>These two communication objects are visible when 1x6byte for the RGBW object type is selected. Apply to control brightness of multi-color lamp, and also support color temperature adjustment.</p>														



6 <sub>MSB</sub>	5	4	3	2	1 <sub>LSB</sub>
R	G	B	W	Reserve	r r r r mR mG mB mW
UUUUUUUU	UUUUUUUU	UUUUUUUU	UUUUUUUU	00000000	0000BBBB

R: red dimming value; G: green dimming value; B: blue dimming value; W: white dimming value;

mR: determines whether the red dimming value is valid, 0 = invalid, 1 = valid;

mG: determines whether the green dimming value is valid, 0 = invalid, 1 = valid;

mB: determines whether the blue dimming value is valid, 0 = invalid, 1 = valid;

mW: Determines whether the white dimming value is valid, 0 = invalid, 1 = valid.

<b>313</b>	<b>Color temperature value</b>	<b>KNX: {{Channel 1}}</b>	<b>2byte</b>	<b>C,T</b>	<b>7.600 absolute color temperature</b>
<b>317</b>	<b>Color temperature, status</b>	<b>KNX: {{Channel 1}}</b>	<b>2byte</b>	<b>C,W,T,U</b>	<b>7.600 absolute color temperature</b>

These two communication objects apply to color temperature adjustment of monochrome lamp.

Telegrams: 2000..7000 K

Obj.313: Used for sending the control telegram of the color temperature to the bus.

Obj.317: Used for receiving the control telegram of the color temperature from bus.

<b>314</b>	<b>Brightness value</b>	<b>KNX: {{Channel 1}}</b>	<b>1byte</b>	<b>C,T</b>	<b>5.001 percentage(0..100%)</b>
<b>318</b>	<b>Brightness, status</b>	<b>KNX: {{Channel 1}}</b>	<b>1byte</b>	<b>C,W,T,U</b>	<b>5.001 percentage(0..100%)</b>

These two communication objects apply to color temperature adjustment of monochrome lamp. Telegrams: 0...100%

Obj.314: Used for sending the dimming telegram of the color temperature to the bus, that is, sending the brightness value.

Obj.318: Used for receiving the brightness status responded from the dimming actuator.

<b>311</b>	<b>Open/Close</b>	<b>KNX: {{Channel 1}}</b>	<b>1bit</b>	<b>C,T</b>	<b>1.009 open/close</b>
<b>312</b>	<b>Stop</b>	<b>KNX: {{Channel 1}}</b>	<b>1bit</b>	<b>C,T</b>	<b>1.007 step</b>

Curtain step/move: these two communication objects apply to open and close curtain. Support to open, close, stop.

Obj.311: Used for sending the telegram to the bus, to control curtain open/close. Telegrams:

<p>1——Close the curtain</p> <p>0——Open the curtain</p> <p>Obj.312: Used for sending the telegram to the bus, to stop curtain movement. Telegrams:</p> <p>1——Stop</p>					
311	Up/Down	KNX: {{Channel 1}}	1bit	C,T	1.008 up/down
312	Stop	KNX: {{Channel 1}}	1bit	C,T	1.007 step
<p>Roller blind step/move: these two communication objects apply to roller blind. Support to up, down, stop.</p> <p>Obj.311: Used for sending the telegram to the bus, to control blind up/down. Telegrams:</p> <p>1——Move down</p> <p>0——Move up</p> <p>Obj.312 is the same as above.</p>					
311	Open/Close	KNX: {{Channel 1}}	1bit	C,T	1.009 open/close
312	Stop	KNX: {{Channel 1}}	1bit	C,T	1.007 step
313	Blind position	KNX: {{Channel 1}}	1byte	C,T	5.001 percentage(0..100%)
315	Blind position, status	KNX: {{Channel 1}}	1byte	C,W,T,U	5.001 percentage(0..100%)
<p>Curtain position: apply to open and close curtain. Support to open, close, stop, position adjustment and position status feedback.</p> <p>Obj.311: Used for sending the telegram to the bus, to control curtain open/close. Telegrams:</p> <p>1——Close the curtain</p> <p>0——Open the curtain</p> <p>Obj.312: Used for sending the telegram to the bus, to stop curtain movement. Telegrams:</p> <p>1——Stop</p> <p>Obj.313: Used for sending a telegram to control the position of the curtain to the bus. Telegrams: 0...100%</p> <p>Obj.315: Used for receiving a curtain position status in response to the window curtain actuator on the bus. Telegrams: 0...100%</p>					
311	Up/Down	KNX: {{Channel 1}}	1bit	C,T	1.008 up/down
312	Stop	KNX: {{Channel 1}}	1bit	C,T	1.007 step
313	Blind position	KNX: {{Channel 1}}	1byte	C,T	5.001 percentage(0..100%)

<b>315</b>	<b>Blind position, status</b>	<b>KNX: {{Channel 1}}</b>	<b>1byte</b>	<b>C,W,T,U</b>	<b>5.001 percentage(0..100%)</b>
<p>Roller blind position: apply to a roller blind without slat. Support to up, down, stop, position adjustment and position status feedback.</p> <p>Obj.311: Used for sending the telegram to the bus, to control blind up/down. Telegrams:</p> <p style="padding-left: 40px;">1——Move down</p> <p style="padding-left: 40px;">0——Move up</p> <p>Obj.312, Obj.313, Obj.315 are the same as above.</p>					
<b>311</b>	<b>Up/Down</b>	<b>KNX: {{Channel 1}}</b>	<b>1bit</b>	<b>C,T</b>	<b>1.008 up/down</b>
<b>312</b>	<b>Stop/Slat adj.</b>	<b>KNX: {{Channel 1}}</b>	<b>1bit</b>	<b>C,T</b>	<b>1.007 step</b>
<b>313</b>	<b>Blind position</b>	<b>KNX: {{Channel 1}}</b>	<b>1byte</b>	<b>C,T</b>	<b>5.001 percentage(0..100%)</b>
<b>314</b>	<b>Slat position</b>	<b>KNX: {{Channel 1}}</b>	<b>1byte</b>	<b>C,T</b>	<b>5.001 percentage(0..100%)</b>
<b>315</b>	<b>Blind position, status</b>	<b>KNX: {{Channel 1}}</b>	<b>1byte</b>	<b>C,W,T,U</b>	<b>5.001 percentage(0..100%)</b>
<b>316</b>	<b>Slat position, status</b>	<b>KNX: {{Channel 1}}</b>	<b>1byte</b>	<b>C,W,T,U</b>	<b>5.001 percentage(0..100%)</b>
<p>Venetian blind position and slat: apply to a blind with slat. Support to up, down, stop, position and slat adjustment, position and slat status feedback.</p> <p>Obj.311、Obj.313 and Obj.315 are same as above.</p> <p>Obj.312: Used for sending a telegram to the bus to stop the curtain movement or adjust the slat angle. Telegrams:</p> <p style="padding-left: 40px;">1——Stop/Slat adj. Down</p> <p style="padding-left: 40px;">0——Stop/Slat adj. Up</p> <p>Obj.314: Used for sending a telegram to control the position of the blind to the bus. Telegrams: 0...100%</p> <p>Obj.316: Used for receiving a blind position status in response to the blind actuator on the bus. Telegrams: 0...100%</p>					
<b>311</b>	<p>Send 1bit value</p> <p>Send 2bit value</p> <p>Send 1byte percent value</p> <p>Send 1byte unsigned value</p> <p>Recall scene No.</p> <p>Send 2byte float value</p> <p>Send 2byte unsigned value</p>	<b>KNX: {{Channel 1}}</b>	<p><b>1bit on/off</b></p> <p><b>2bit 0..3</b></p> <p><b>1byte 0..100%</b></p> <p><b>1byte 0..255</b></p> <p><b>1byte 1..64</b></p> <p><b>2byte -671088.64..670760.96</b></p> <p><b>2byte 0..65535</b></p>	<b>C,T</b>	<p><b>1.001 switch</b></p> <p><b>2.001 switch control</b></p> <p><b>5.001 percentage(0..100%)</b></p> <p><b>5.010 counter pulses</b></p> <p><b>17.001 scene number</b></p> <p><b>9.x float value</b></p> <p><b>7.001 pulses</b></p>

The communication object is used for sending a preset telegram to the bus when trigger the calling command on the APP. Object type and value range are determined by the parameter setting datatype.					
<b>311</b>	<b>Trigger scene No.</b>	<b>KNX: {{Channel 1}}</b>	<b>2byte</b>	<b>C,W</b>	<b>17.001 scene number</b>
The communication object is used for receiving the scene triggered telegram from KNX system. Telegram: 1..64					

Table 6.2.1 Basic function communication object table

### 6.2.2. Communication Object of Air condition

Numb	Name	Object Function	Description	Group Address	Length	C	R	W	T	U	Data Type	Priority
311	KNX: Channel 1	Power on/off			1 bit	C	-	-	T	-	switch	Low
312	KNX: Channel 1	Current setpoint adjustment			2 bytes	C	-	-	T	-	temperature (°C)	Low
313	KNX: Channel 1	Control mode			1 byte	C	-	-	T	-	HVAC control mode	Low
314	KNX: Channel 1	Fan speed			1 byte	C	-	-	T	-	percentage (0..100%)	Low
317	KNX: Channel 1	Power on/off status			1 bit	C	-	W	-	-	switch	Low
318	KNX: Channel 1	Room temperature sensor			2 bytes	C	-	W	T	U	temperature (°C)	Low
319	KNX: Channel 1	Current temperature setpoint, status			2 bytes	C	-	W	-	U	temperature (°C)	Low
320	KNX: Channel 1	Control mode, status			1 byte	C	-	W	-	-	HVAC control mode	Low
321	KNX: Channel 1	Fan speed, status			1 byte	C	-	W	-	-	percentage (0..100%)	Low

Air conditioner

Numb	Name	Object Function	Description	Group Address	Length	C	R	W	T	U	Data Type	Priority
311	KNX: Channel 1	Power on/off			1 bit	C	-	-	T	-	switch	Low
312	KNX: Channel 1	Current setpoint adjustment			2 bytes	C	-	-	T	-	temperature (°C)	Low
313	KNX: Channel 1	Control mode			1 byte	C	-	-	T	-	HVAC control mode	Low
314	KNX: Channel 1	Fan speed			1 byte	C	-	-	T	-	percentage (0..100%)	Low
315	KNX: Channel 1	Vanes swing (1-swing,0-stop)			1 bit	C	-	-	T	-	start/stop	Low
317	KNX: Channel 1	Power on/off, status			1 bit	C	-	W	-	-	switch	Low
318	KNX: Channel 1	Room temperature sensor			2 bytes	C	-	W	T	U	temperature (°C)	Low
319	KNX: Channel 1	Current temperature setpoint, status			2 bytes	C	-	W	-	U	temperature (°C)	Low
320	KNX: Channel 1	Control mode, status			1 byte	C	-	W	-	-	HVAC control mode	Low
321	KNX: Channel 1	Fan speed, status			1 byte	C	-	W	-	-	percentage (0..100%)	Low
322	KNX: Channel 1	Vanes swing (1-swing,0-stop), status			1 bit	C	-	W	-	-	start/stop	Low

Air conditioner(with swing)

Fig.6.2.2 Air condition function communication object

NO.	Object Function	Name	Data Type	Flag	DPT
<b>311</b>	<b>Power on/off</b>	<b>KNX: {{Channel 1}}</b>	<b>1bit</b>	<b>C,T</b>	<b>1.001 switch</b>
The communication object is used to control air condition power on/off via the APP, and send the telegram value to the bus. Telegrams: 1—On 0—Off					
<b>312</b>	<b>Current setpoint adjustment</b>	<b>KNX: {{Channel 1}}</b>	<b>2byte</b>	<b>C,T</b>	<b>9.001 temperature</b>
The communication object is used to adjust setpoint temperature via the APP, and send telegram value to the bus.					

313	Control mode	KNX: {{Channel 1}}	1byte	C,T	20.105 HVAC control mode
<p>The communication object is used to send control telegram of each air condition mode to the bus.</p> <p>Different telegram means different control mode:</p> <p>0-Auto, 1- Heating, 3-Cooling, 9-Fan, 14-Dehumidity, other reserved.</p>					
314	Fan speed	KNX: {{Channel 1}}	1byte	C,T	5.001 percentage 5.100 fan stage
<p>The communication object is used to send control telegram of each fan speed to the bus. Telegram value is determined by parameter setting datatype.</p>					
315	Vanes swing (1-swing,0-stop)	KNX: {{Channel 1}}	1bit	C,T	1.010 start/stop
<p>The communication object is visible only when “Air conditioner(with swing)” is selected. Used to send telegram controlling vanes swing to the bus. Telegrams:</p> <p style="padding-left: 40px;">1——Swing</p> <p style="padding-left: 40px;">0——Stop</p>					
317	Power on/off, status	KNX: {{Channel 1}}	1bit	C,W	1.001 switch
<p>The communication object is used to receive the power on/off telegram of air condition from the bus, and feedback to the APP display. Telegrams:</p> <p style="padding-left: 40px;">1——On</p> <p style="padding-left: 40px;">0——Off</p>					
318	Room temperature sensor	KNX: {{Channel 1}}	2byte	C,W,T,U	9.001 temperature
<p>The communication object is used to receive the room temperature from the bus, and send read request cyclically, and feedback to the APP display.</p>					
319	Current temperature setpoint, status	KNX: {{Channel 1}}	2byte	C,W,U	9.001 temperature
<p>The communication object is used to receive the current setpoint temperature from the bus, and feedback to the APP display.</p>					
320	Control mode, status	KNX: {{Channel 1}}	1byte	C,W	20.105 HVAC control mode
<p>The communication object is used to receive the current control mode from the bus, and feedback to the APP display. Different telegram means different control mode:</p> <p>0-Auto, 1- Heating, 3-Cooling, 9-Fan, 14-Dehumidity, other reserved.</p>					
321	Fan speed, status	KNX: {{Channel 1}}	1byte	C,W	5.001 percentage 5.100 fan stage

<p>The communication object is used to receive the current fan speed from the bus, and feedback to the APP display. Telegram value is determined by parameter setting datatype.</p>					
<b>322</b>	<b>Vanes swing (1-swing,0-stop), status</b>	<b>KNX: {{Channel 1}}</b>	<b>1bit</b>	<b>C,W</b>	<b>1.010 start/stop</b>
<p>The communication object is visible only when “Air conditioner(with swing)” is selected. Used to receive vanes swing status from the bus. Telegrams:</p> <p style="margin-left: 40px;">1——Swing</p> <p style="margin-left: 40px;">0——Stop</p>					

Table 6.2.2 Air condition function communication object table

**6.2.3. Communication Object of Room temperature unit**

Numb	Name	Object Function	Description	Group Address	Length	C	R	W	T	U	Data Type	Priority
311	KNX: Channel 1	Power on/off			1 bit	C	-	-	T	-	switch	Low
312	KNX: Channel 1	Current setpoint adjustment			2 bytes	C	-	-	T	-	temperature (°C)	Low
313	KNX: Channel 1	Heating/Cooling mode			1 bit	C	-	-	T	-	cooling/heating	Low
325	KNX: Channel 1	Power on/off, status			1 bit	C	-	W	-	-	switch	Low
326	KNX: Channel 1	Room temperature sensor			2 bytes	C	-	W	T	U	temperature (°C)	Low
327	KNX: Channel 1	Current temperature setpoint, status			2 bytes	C	-	W	-	U	temperature (°C)	Low
328	KNX: Channel 1	Heating/Cooling mode, status			1 bit	C	-	W	-	-	cooling/heating	Low

**Room temperature unit**

Numb	Name	Object Function	Description	Group Address	Length	C	R	W	T	U	Data Type	Priority
311	KNX: Channel 1	Power on/off			1 bit	C	-	-	T	-	switch	Low
312	KNX: Channel 1	Current setpoint adjustment			2 bytes	C	-	-	T	-	temperature (°C)	Low
313	KNX: Channel 1	Heating/Cooling mode			1 bit	C	-	-	T	-	cooling/heating	Low
314	KNX: Channel 1	Operation mode			1 byte	C	-	-	T	-	HVAC mode	Low
325	KNX: Channel 1	Power on/off, status			1 bit	C	-	W	-	-	switch	Low
326	KNX: Channel 1	Room temperature sensor			2 bytes	C	-	W	T	U	temperature (°C)	Low
327	KNX: Channel 1	Current temperature setpoint, status			2 bytes	C	-	W	-	U	temperature (°C)	Low
328	KNX: Channel 1	Heating/Cooling mode, status			1 bit	C	-	W	-	-	cooling/heating	Low
329	KNX: Channel 1	Operation mode, status			1 byte	C	-	W	-	-	HVAC mode	Low

**Room temperature unit(with operation mode)**

Numb	Name	Object Function	Description	Group Address	Length	C	R	W	T	U	Data Type	Priority
311	KNX: Channel 1	Power on/off			1 bit	C	-	-	T	-	switch	Low
312	KNX: Channel 1	Current setpoint adjustment			2 bytes	C	-	-	T	-	temperature (°C)	Low
313	KNX: Channel 1	Heating/Cooling mode			1 bit	C	-	-	T	-	cooling/heating	Low
314	KNX: Channel 1	Operation mode			1 byte	C	-	-	T	-	HVAC mode	Low
319	KNX: Channel 1	Fan speed			1 byte	C	-	-	T	-	percentage (0..100%)	Low
320	KNX: Channel 1	Fan speed low			1 bit	C	-	-	T	-	switch	Low
321	KNX: Channel 1	Fan speed medium			1 bit	C	-	-	T	-	switch	Low
322	KNX: Channel 1	Fan speed high			1 bit	C	-	-	T	-	switch	Low
324	KNX: Channel 1	Fan automatic operation			1 bit	C	-	-	T	-	enable	Low
325	KNX: Channel 1	Power on/off, status			1 bit	C	-	W	-	-	switch	Low
326	KNX: Channel 1	Room temperature sensor			2 bytes	C	-	W	T	U	temperature (°C)	Low
327	KNX: Channel 1	Current temperature setpoint, status			2 bytes	C	-	W	-	U	temperature (°C)	Low
328	KNX: Channel 1	Heating/Cooling mode, status			1 bit	C	-	W	-	-	cooling/heating	Low
329	KNX: Channel 1	Operation mode, status			1 byte	C	-	W	-	-	HVAC mode	Low
334	KNX: Channel 1	Fan speed, status			1 byte	C	-	W	-	-	percentage (0..100%)	Low
335	KNX: Channel 1	Fan speed low, status			1 bit	C	-	W	-	-	switch	Low
336	KNX: Channel 1	Fan speed medium, status			1 bit	C	-	W	-	-	switch	Low
337	KNX: Channel 1	Fan speed high, status			1 bit	C	-	W	-	-	switch	Low
339	KNX: Channel 1	Fan automatic operation, status			1 bit	C	-	W	-	-	enable	Low

Room temperature unit(with operation mode & fan speed)  
**Fig.6.2.3 Room temperature unit function communication Object**

NO.	Object Function	Name	Data Type	Flag	DPT
311	<b>Power on/off</b>	<b>KNX: {{Channel 1}}</b>	<b>1bit</b>	<b>C,T</b>	<b>1.001 switch</b>
<p>The communication object is used to control RTC power on/off via the APP, and send the telegram value to the bus. Telegrams:</p> <p style="text-align: center;">1—On</p> <p style="text-align: center;">0—Off</p>					
312	<b>Current setpoint adjustment</b>	<b>KNX: {{Channel 1}}</b>	<b>2byte</b>	<b>C,T</b>	<b>9.001 temperature</b>
<p>The communication object is used to adjust setpoint temperature via the APP, and send telegram value to the bus.</p>					
313	<b>Heating/Cooling mode</b>	<b>KNX: {{Channel 1}}</b>	<b>1bit</b>	<b>C,T</b>	<b>1.100 cooling/heating</b>



The communication object is used to send telegram for switching cooling and heating functions to the bus.  
Telegrams:

1—Heating

0—Cooling

<b>314</b>	<b>Operation mode</b>	<b>KNX: {{Channel 1}}</b>	<b>1byte</b>	<b>C,T</b>	<b>20.102 HVAC mode</b>
------------	-----------------------	---------------------------	--------------	------------	-------------------------

The communication object is used to send the telegram of the room operation mode to the bus. Different telegram means different control mode:

1-Comfort, 2-Standby, 3-Economy, 4-Protection, other reserved.

<b>319</b>	<b>Fan speed</b>	<b>KNX: {{Channel 1}}</b>	<b>1byte</b>	<b>C,T</b>	<b>5.001 percentage</b> <b>5.100 fan stage</b>
<b>320</b>	<b>Fan speed low</b>	<b>KNX: {{Channel 1}}</b>	<b>1bit</b>	<b>C,T</b>	<b>1.001 switch</b>
<b>321</b>	<b>Fan speed medium</b>	<b>KNX: {{Channel 1}}</b>	<b>1bit</b>	<b>C,T</b>	<b>1.001 switch</b>
<b>322</b>	<b>Fan speed high</b>	<b>KNX: {{Channel 1}}</b>	<b>1bit</b>	<b>C,T</b>	<b>1.001 switch</b>
<b>323</b>	<b>Fan speed off</b>	<b>KNX: {{Channel 1}}</b>	<b>1bit</b>	<b>C,T</b>	<b>1.001 switch</b>

These communication objects are used to control fan speed via the APP, and send telegrams to the bus.

1bit object is visible according to the parameter setting :

Object 320—Low fan speed

Object 321—Medium fan speed

Object 322—High fan speed

Object 323—Fan speed off

Only the corresponding object sends telegram “1” when switch to a certain fan speed. When 1bit-off object is not enable, all objects send telegrams “0” when switch to fan speed off (The situation apply to connect with fan actuator of GVS);

When 1bit-off object is enable, only 1bit-off object send telegram “1” (The situation apply to connect with fan actuator of other manufacturers).

1byte: the corresponding telegram value of each fan speed is defined by the parameter. Activate the corresponding fan speed on the APP, and object 319 sends the corresponding telegram value of the fan speed to the bus.

<b>324</b>	<b>Fan automatic operation</b>	<b>KNX: {{Channel 1}}</b>	<b>1bit</b>	<b>C,T</b>	<b>1.003 enable</b>
------------	--------------------------------	---------------------------	-------------	------------	---------------------

The communication object is used to send the telegram of fan automatic control to the bus. Telegrams:



			1—Auto			
			0—Exit auto			
325	Power on/off, status	KNX: {{Channel 1}}	1bit	C,W		1.001 switch
<p>The communication object is used to receive the power on/off telegram of RTC from the bus, and feedback to the APP display. Telegrams:</p> <p>1—On</p> <p>0—Off</p>						
326	Room temperature sensor	KNX: {{Channel 1}}	2byte	C,W,T,U		9.001 temperature
<p>The communication object is used to receive the room temperature from the bus, and send read request cyclically, and feedback to the APP display.</p>						
327	Current temperature setpoint, status	KNX: {{Channel 1}}	2byte	C,W,U		9.001 temperature
<p>The communication object is used to receive the current setpoint temperature from the bus, and feedback to the APP display.</p>						
328	Heating/Cooling mode, status	KNX: {{Channel 1}}	1bit	C,W		1.100 cooling/heating
<p>The communication object is used for receiving the status of heating and cooling from the bus, and feedback to the APP display. Telegrams:</p> <p>1 —Heating</p> <p>0 —Cooling</p>						
329	Operation mode, status	KNX: {{Channel 1}}	1byte	C,W		20.102 HVAC mode
<p>The communication object is used for receiving the telegram of RTC operation mode from the bus. Different telegram means different control mode:</p> <p>1-Comfort, 2-Standby, 3-Economy, 4-Protection, other reserved.</p>						
334	Fan speed, status	KNX: {{Channel 1}}	1byte	C,W		5.001 percentage 5.100 fan stage
335	Fan speed low, status	KNX: {{Channel 1}}	1bit	C,W		1.001 switch
336	Fan speed medium, status	KNX: {{Channel 1}}	1bit	C,W		1.001 switch
337	Fan speed high, status	KNX: {{Channel 1}}	1bit	C,W		1.001 switch
338	Fan speed off, status	KNX: {{Channel 1}}	1bit	C,W		1.001 switch
<p>These communication objects are used to receive status feedback to control fan speed via four 1bit objects or a 1byte object.</p>						

1bit :

Object 335——Low fan speed

Object 336——Medium fan speed

Object 337——High fan speed

Object 338——Fan speed off

The object receives telegram “1”, activate corresponding fan speed, and feedback to the APP display. When 1bit-off object is not enable, fan speed off when telegram values of low/medium/high fan speed are “0”;

When 1bit-off object is enable, fan speed off when 1bit-off object receives telegram “1”, and fan speed also off when telegram values of low/medium/high fan speed are “0”

1byte: the corresponding telegram value of each fan speed is defined by the parameter. When object 334 receives the corresponding value, update the fan speed status on the APP display.

<b>339</b>	<b>Fan automatic operation, status</b>	<b>KNX: {{Channel 1}}</b>	<b>1bit</b>	<b>C,W</b>	<b>1.003 enable</b>
<p>The communication object is used to receive feedback status of fan automatic control. Telegrams:</p> <p>1——Automatic</p> <p>0——Cancel automatic</p>					

Table 6.2.3 Room temperature unit function communication object table

### 6.2.4. Communication Object of Ventilation system

Numb	Name	Object Function	Description	Group Address	Length	C	R	W	T	U	Data Type	Priority
311	KNX: Channel 1	Power on/off			1 bit	C	-	-	T	-	switch	Low
312	KNX: Channel 1	Fan speed			1 byte	C	-	-	T	-	percentage (0..100%)	Low
313	KNX: Channel 1	Fan speed low			1 bit	C	-	-	T	-	switch	Low
314	KNX: Channel 1	Fan speed medium			1 bit	C	-	-	T	-	switch	Low
315	KNX: Channel 1	Fan speed high			1 bit	C	-	-	T	-	switch	Low
316	KNX: Channel 1	Fan automatic operation			1 bit	C	-	-	T	-	enable	Low
317	KNX: Channel 1	Heat recovery			1 bit	C	-	-	T	-	enable	Low
318	KNX: Channel 1	Power on/off, status			1 bit	C	-	W	-	-	switch	Low
319	KNX: Channel 1	Fan speed, status			1 byte	C	-	W	-	-	percentage (0..100%)	Low
320	KNX: Channel 1	Fan speed low, status			1 bit	C	-	W	-	-	switch	Low
321	KNX: Channel 1	Fan speed medium, status			1 bit	C	-	W	-	-	switch	Low
322	KNX: Channel 1	Fan speed high, status			1 bit	C	-	W	-	-	switch	Low
323	KNX: Channel 1	Fan automatic operation, status			1 bit	C	-	W	-	-	enable	Low
324	KNX: Channel 1	Heat recovery, status			1 bit	C	-	W	-	-	enable	Low
325	KNX: Channel 1	Filter alarm, status			1 bit	C	-	W	-	-	alarm	Low

Ventilation system

Fig.6.2.4 Ventilation system function communication object

NO.	Object Function	Name	Data Type	Flag	DPT
<b>311</b>	<b>Power on/off</b>	<b>KNX: {{Channel 1}}</b>	<b>1bit</b>	<b>C,T</b>	<b>1.001 switch</b>

The communication object is used to control ventilation power on/off via the APP, and send the telegram value to the bus. Telegrams:

1—On

0—Off

<b>312</b>	<b>Fan speed</b>	<b>KNX: {{Channel 1}}</b>	<b>1byte</b>	<b>C,T</b>	<b>5.001 percentage</b> <b>5.100 fan stage</b>
<b>313</b>	<b>Fan speed low</b>	<b>KNX: {{Channel 1}}</b>	<b>1bit</b>	<b>C,T</b>	<b>1.001 switch</b>
<b>314</b>	<b>Fan speed medium</b>	<b>KNX: {{Channel 1}}</b>	<b>1bit</b>	<b>C,T</b>	<b>1.001 switch</b>
<b>315</b>	<b>Fan speed high</b>	<b>KNX: {{Channel 1}}</b>	<b>1bit</b>	<b>C,T</b>	<b>1.001 switch</b>

These communication objects are used to send the control telegrams of fan speed to the bus.

1byte: the corresponding telegram value of each fan speed is defined by the parameter. Activate the corresponding fan speed on the APP, and object 312 sends the corresponding telegram value of the fan speed to the bus.

1bit:

Object 313—Low fan speed

Object 314—Medium fan speed

Object 315—High fan speed

The corresponding object sends telegram “1” to activate corresponding fan speed on the APP. Turn off fan speed when send telegram “0”.

<b>316</b>	<b>Fan automatic operation</b>	<b>KNX: {{Channel 1}}</b>	<b>1bit</b>	<b>C,T</b>	<b>1.003 enable</b>
------------	--------------------------------	---------------------------	-------------	------------	---------------------

The communication object is used to send the telegram of fan automatic control to the bus. Telegrams:

1—Auto

0—Exit auto

<b>317</b>	<b>Heat recovery</b>	<b>KNX: {{Channel 1}}</b>	<b>1bit</b>	<b>C,T</b>	<b>1.003 enable</b>
------------	----------------------	---------------------------	-------------	------------	---------------------

The communication object is used to control heat recovery mode via the APP, and send telegram to the bus. Telegrams:

1—Active

0—Inactive

<b>318</b>	<b>Power on/off, status</b>	<b>KNX: {{Channel 1}}</b>	<b>1bit</b>	<b>C,W</b>	<b>1.001 switch</b>
<p>The communication object is used to receive the power on/off telegram of ventilation from the bus, and feedback to the APP display. Telegrams:</p> <p style="padding-left: 40px;">1—On</p> <p style="padding-left: 40px;">0—Off</p>					
<b>319</b>	<b>Fan speed, status</b>	<b>KNX: {{Channel 1}}</b>	<b>1byte</b>	<b>C,W</b>	<b>5.001 percentage</b> <b>5.100 fan stage</b>
<b>320</b>	<b>Fan speed low, status</b>	<b>KNX: {{Channel 1}}</b>	<b>1bit</b>	<b>C,W</b>	<b>1.001 switch</b>
<b>321</b>	<b>Fan speed medium, status</b>	<b>KNX: {{Channel 1}}</b>	<b>1bit</b>	<b>C,W</b>	<b>1.001 switch</b>
<b>322</b>	<b>Fan speed high, status</b>	<b>KNX: {{Channel 1}}</b>	<b>1bit</b>	<b>C,W</b>	<b>1.001 switch</b>
<p>These communication objects are used to receive status feedback to control fan speed via three 1bit objects or a 1byte object.</p> <p>1byte: the corresponding telegram value of each fan speed is defined by the parameter. When object 319 receives the corresponding value, update the fan speed status on the APP display.</p> <p>1bit :</p> <p style="padding-left: 40px;">Object 320—Low fan speed</p> <p style="padding-left: 40px;">Object 321—Medium fan speed</p> <p style="padding-left: 40px;">Object 322—High fan speed</p> <p>The object receives telegram “1”, activate corresponding fan speed, and and feedback to the APP display. All telegram values of fan speed should be 0 when turn off fan speed;</p>					
<b>323</b>	<b>Fan automatic operation, status</b>	<b>KNX: {{Channel 1}}</b>	<b>1bit</b>	<b>C,W</b>	<b>1.003 enable</b>
<p>The communication object is used to receive feedback status of fan automatic control. Telegrams:</p> <p style="padding-left: 40px;">1—Automatic</p> <p style="padding-left: 40px;">0—Cancel automatic</p>					
<b>324</b>	<b>Heat recovery, status</b>	<b>KNX: {{Channel 1}}</b>	<b>1bit</b>	<b>C,W</b>	<b>1.003 enable</b>
<p>The communication object is used to receive status of heat recovery mode, and feedback to the APP display. Telegrams:</p> <p style="padding-left: 40px;">1—Active</p> <p style="padding-left: 40px;">0—Inactive</p>					
<b>325</b>	<b>Filter alarm, status</b>	<b>KNX: {{Channel 1}}</b>	<b>1bit</b>	<b>C,W</b>	<b>1.005 alarm</b>

The communication object is used to receive filter status from the bus, and feedback to the APP display.  
Telegrams:

- 1——In normal use
- 0——Replace alarm

Table 6.2.4 Ventilation system function communication object table

**6.2.5. Communication Object of Audio control**

Numb	Name	Object Function	Description	Group Address	Length	C	R	W	T	U	Data Type	Priority
312	KNX: Channel 1	Play=1/Pause=0			1 bit	C	-	-	T	-	start/stop	Low
313	KNX: Channel 1	Next track=1/Previous track=0			1 bit	C	-	-	T	-	step	Low
314	KNX: Channel 1	Volume+=1/Volume-=0			1 bit	C	-	-	T	-	step	Low
315	KNX: Channel 1	Absolute volume			1 byte	C	-	-	T	-	percentage (0..100%)	Low
316	KNX: Channel 1	Mute			1 bit	C	-	-	T	-	enable	Low
317	KNX: Channel 1	Play mode			1 byte	C	-	-	T	-	counter pulses (0..255)	Low
319	KNX: Channel 1	Play=1/Pause=0, status			1 bit	C	-	W	T	U	start/stop	Low
320	KNX: Channel 1	Absolute volume, status			1 byte	C	-	W	T	U	percentage (0..100%)	Low
321	KNX: Channel 1	Mute, status			1 bit	C	-	W	T	U	enable	Low
322	KNX: Channel 1	Play mode, status			1 byte	C	-	W	T	U	counter pulses (0..255)	Low

Audio control

Numb	Name	Object Function	Description	Group Address	Length	C	R	W	T	U	Data Type	Priority
311	KNX: Channel 1	Power on/off			1 bit	C	-	-	T	-	switch	Low
312	KNX: Channel 1	Play=1/Pause=0			1 bit	C	-	-	T	-	start/stop	Low
313	KNX: Channel 1	Next track=1/Previous track=0			1 bit	C	-	-	T	-	step	Low
314	KNX: Channel 1	Volume+=1/Volume-=0			1 bit	C	-	-	T	-	step	Low
317	KNX: Channel 1	Play mode			1 byte	C	-	-	T	-	counter pulses (0..255)	Low
318	KNX: Channel 1	Power on/off, status			1 bit	C	-	W	-	-	switch	Low
319	KNX: Channel 1	Play=1/Pause=0, status			1 bit	C	-	W	-	-	start/stop	Low
322	KNX: Channel 1	Play mode, status			1 byte	C	-	W	-	-	counter pulses (0..255)	Low

Audio control(with on/off)

Fig.6.2.5 Audio control function communication object

**Note: If “Audio control(with on/off)” is selected, default as power off when voltage recovery, and the object no need to send read request telegram. If “Audio control” is selected, the object needs to send read request telegram when voltage recovery.**

NO.	Object Function	Name	Data Type	Flag	DPT
311	<b>Power on/off</b>	<b>KNX: {{Channel 1}}</b>	<b>1bit</b>	<b>C,T</b>	<b>1.001 switch</b>
<p>The communication object only applies to the audio control with power on/off. Used to to control the audio power on/off via the APP, and send the telegram to the bus. Telegrams:</p> <ul style="list-style-type: none"> <li>1——On</li> <li>0——Off</li> </ul>					
312	<b>Play=1/Pause=0</b>	<b>KNX: {{Channel 1}}</b>	<b>1bit</b>	<b>C,T</b>	<b>1.010 start/stop</b>
<p>The communication object is used to play/stop the music in the audio module via the APP. Telegrams:</p>					

			1——Play music 0——Pause playing music		
313	Next track=1/Previous track=0	KNX: {{Channel 1}}	1bit	C,T	1.007 step
<p>The communication object is used to switch the playing song of the audio module via the APP, to switch the previous song/the next song. Telegrams:</p> <p>1——Play the next song 0——Play the previous song</p>					
314	Volume+=1/Volume-=0	KNX: {{Channel 1}}	1bit	C,T	1.007 step
315	Absolute volume	KNX: {{Channel 1}}	1byte	C,T	5.001 percentage 5.004 percentage
<p>The communication object is used to adjust volume of the audio module via the APP. Telegram value is determined by different object datatype.</p> <p>1 bit object, telegrams:</p> <p>1——Increase volume 0——Decrease volume</p> <p>1 byte object only applies to the audio control function without power on/off. Telegram value is according to object type: 0..100 / 0..255</p>					
316	Mute	KNX: {{Channel 1}}	1bit	C,T	1.003 enable
<p>The communication object only applies to the audio control function without power on/off, used to control mute of the audio module via the APP. Telegrams:</p> <p>1——Mute 0——Cancel mute</p>					
317	Play mode	KNX: {{Channel 1}}	1byte	C,T	5.010 counter pulses
<p>The communication object is used to send control telegram of the audio module play mode, different mode telegrams are preset by parameters.</p>					
318	Power on/off, status	KNX: {{Channel 1}}	1bit	C,W	1.001 switch
<p>The communication object only applies to the audio control function with power on/off. Used to receive the power on/off telegram of the audio module from the bus.</p>					
319	Play=1/Pause=0, status	KNX: {{Channel 1}}	1bit	C,W C,W,T,U	1.010 start/stop

<p>The communication object is used to receive the music play/stop status from the bus.</p> <p>When the audio control function with power on/off, the object flag is C,W; And without power on/off, the object flag is C,W,T,U.</p>					
<b>320</b>	<b>Absolute volume, status</b>	<b>KNX: {{Channel 1}}</b>	<b>1byte</b>	<b>C,W,T,U</b>	<b>5.001 percentage</b> <b>5.004 percentage</b>
<p>Volume adjustment function, 1byte object only applies to the audio control function without power on/off. Used to receive the volume status of audio control.</p> <p>Telegram value is according to object type: 0..100 / 0..255</p>					
<b>321</b>	<b>Mute, status</b>	<b>KNX: {{Channel 1}}</b>	<b>1bit</b>	<b>C,W,T,U</b>	<b>1.003 enable</b>
<p>The communication object only applies to the audio control function without power on/off. Used to receive the mute status of audio control.</p>					
<b>322</b>	<b>Play mode, status</b>	<b>KNX: {{Channel 1}}</b>	<b>1byte</b>	<b>C,W</b> <b>C,W,T,U</b>	<b>5.010 counter pulses</b>
<p>The communication object is used to receive the play mode status of the audio module from the bus, different mode telegrams are preset by parameters.</p> <p>When the audio control function with power on/off, the object flag is C,W; And without power on/off, the object flag is C,W,T,U.</p>					

Table 6.2.5 Audio control function communication object table

**6.2.6. Communication Object of sensor function**

Numb	Name	Object Function	Description	Group Address	Length	C	R	W	T	U	Data Type	Priority
311	KNX: Channel 1	PM2.5 value			2 bytes	C	-	W	T	U	pulses	Low
312	KNX: Channel 1	PM10 value			2 bytes	C	-	W	T	U	pulses	Low
313	KNX: Channel 1	VOC value			2 bytes	C	-	W	T	U	pulses	Low
314	KNX: Channel 1	CO2 value			2 bytes	C	-	W	T	U	pulses	Low
311	KNX: Channel 1	PM2.5 value			2 bytes	C	-	W	T	U	concentration (µg/m <sup>3</sup> )	Low
312	KNX: Channel 1	PM10 value			2 bytes	C	-	W	T	U	concentration (µg/m <sup>3</sup> )	Low
313	KNX: Channel 1	VOC value			2 bytes	C	-	W	T	U	concentration (µg/m <sup>3</sup> )	Low
314	KNX: Channel 1	CO2 value			2 bytes	C	-	W	T	U	parts/million (ppm)	Low
315	KNX: Channel 1	AQI value			2 bytes	C	-	W	T	U	pulses	Low
316	KNX: Channel 1	Temperature value			2 bytes	C	-	W	T	U	temperature (°C)	Low
317	KNX: Channel 1	Humidity value			2 bytes	C	-	W	T	U	humidity (%)	Low
Air quality sensor												
Numb	Name	Object Function	Description	Group Address	Length	C	R	W	T	U	Data Type	Priority
314	KNX: Channel 1	CO2 value			2 bytes	C	-	W	T	U	pulses	Low
314	KNX: Channel 1	CO2 value			2 bytes	C	-	W	T	U	parts/million (ppm)	Low
316	KNX: Channel 1	Temperature value			2 bytes	C	-	W	T	U	temperature (°C)	Low
317	KNX: Channel 1	Humidity value			2 bytes	C	-	W	T	U	humidity (%)	Low

CO2 sensor



Numb	Name	Object Function	Description	Group Address	Length	C	R	W	T	U	Data Type	Priority
311	KNX: Channel 1	PM2.5 value			2 bytes	C	-	W	T	U	pulses	Low
311	KNX: Channel 1	PM2.5 value			2 bytes	C	-	W	T	U	concentration (µg/m³)	Low
316	KNX: Channel 1	Temperature value			2 bytes	C	-	W	T	U	temperature (°C)	Low
317	KNX: Channel 1	Humidity value			2 bytes	C	-	W	T	U	humidity (%)	Low
PM2.5 sensor												
Numb	Name	Object Function	Description	Group Address	Length	C	R	W	T	U	Data Type	Priority
313	KNX: Channel 1	VOC value			2 bytes	C	-	W	T	U	pulses	Low
313	KNX: Channel 1	VOC value			2 bytes	C	-	W	T	U	concentration (µg/m³)	Low
316	KNX: Channel 1	Temperature value			2 bytes	C	-	W	T	U	temperature (°C)	Low
317	KNX: Channel 1	Humidity value			2 bytes	C	-	W	T	U	humidity (%)	Low
VOC sensor												
Numb	Name	Object Function	Description	Group Address	Length	C	R	W	T	U	Data Type	Priority
311	KNX: Channel 1	Presence detector			1 bit	C	-	W	T	U	occupancy	Low
312	KNX: Channel 1	Brightness value(lux)			2 bytes	C	-	W	T	U	lux (Lux)	Low
312	KNX: Channel 1	Brightness value(lux)			2 bytes	C	-	W	T	U	brightness (lux)	Low
Presence sensor												
Numb	Name	Object Function	Description	Group Address	Length	C	R	W	T	U	Data Type	Priority
311	KNX: Channel 1	Motion detector			1 bit	C	-	W	T	U	occupancy	Low
Motion sensor												
Numb	Name	Object Function	Description	Group Address	Length	C	R	W	T	U	Data Type	Priority
312	KNX: Channel 1	Brightness value(lux)			2 bytes	C	-	W	T	U	lux (Lux)	Low
312	KNX: Channel 1	Brightness value(lux)			2 bytes	C	-	W	T	U	brightness (lux)	Low
Brightness sensor												
Numb	Name	Object Function	Description	Group Address	Length	C	R	W	T	U	Data Type	Priority
311	KNX: Channel 1	I/O signal value			1 bit	C	-	W	T	U	switch	Low

I/O signal  
Fig.6.2.6 Sensor function communication object

NO.	Object Function	Name	Data Type	Flag	DPT
311	PM2.5 value	KNX: {{Channel 1}}	2byte	C,W,T,U	7.001 pulse 9.030 concentration(ug/m3)
<p>The communication object is used to receive the input of the PM2.5 value and get the corresponding value from the bus to be updated to the APP display in ug/m<sup>3</sup>.</p> <p>Range: 0~999ug/m<sup>3</sup>, object datatype is determined by the parameter setting.</p>					
312	PM10 value	KNX: {{Channel 1}}	2byte	C,W,T,U	7.001 pulse 9.030 concentration(ug/m3)
<p>The communication object is used to receive the input of the PM10 value and get the corresponding value from the bus to be updated to the APP display in ug/m<sup>3</sup>.</p> <p>Range: 0~999ug/m<sup>3</sup>, object datatype is determined by the parameter setting.</p>					
313	VOC value	KNX: {{Channel 1}}	2byte	C,W,T,U	7.001 pulse 9.030 concentration(ug/m3)
<p>The communication object is used to receive the input of the VOC value and get the corresponding value from the bus to be updated to the APP display in ug/m<sup>3</sup>.</p> <p>Range: 0~999ug/m<sup>3</sup>, object datatype is determined by the parameter setting.</p>					
314	CO2 value	KNX: {{Channel 1}}	2byte	C,W,T,U	7.001 pulse 9.008 parts/million(ppm)



<p>The communication object is used to receive the input of the CO2 value and get the corresponding value from the bus to be updated to the APP display in ppm.</p> <p>Range: 0...4000ppm</p>					
316	AQI value	KNX: {{Channel 1}}	2byte	C,W,T,U	7.001 pulses
<p>The communication object is used to receive the input of the AQI value and get the corresponding value from the bus to be updated to the APP display. Range: 0...500</p>					
317	Temperature value	KNX: {{Channel 1}}	2byte	C,W,T,U	9.001 temperature
<p>The communication object is used to receive the input of the temperature value and get the corresponding value from the temperature sensor on bus to be updated to the APP display. Range: -40...40°C</p>					
311	Humidity value	KNX: {{Channel 1}}	2byte	C,W,T,U	9.007 humidity
<p>The communication object is used to receive the input of the humidity value and get the corresponding value from the humidity sensor on bus to be updated to the APP display. Range: 0...100%</p>					
312	Brightness value(lux)	KNX: {{Channel 1}}	2byte	C,W,T,U	7.013 brightness(lux) 9.004 lux(lux)
<p>The communication object is used to receive the input of the brightness value and get the corresponding value from the bus to be updated to the APP display in lux.</p> <p>Range: 0...65535lux, object datatype is determined by the parameter setting.</p>					
311	Motion detector	KNX: {{Channel 1}}	1bit	C,W,T,U	1.018 Occupancy
<p>The communication object is used to receive the input of the 1bit presence signal. Telegram:</p> <p>0——No one</p> <p>1——Some one</p>					
311	I/O signal value	KNX: {{Channel 1}}	1bit	C,W,T,U	1.001 switch
<p>The communication object is used to receive the input of the 1bit I/O signal. Telegram:</p> <p>0——Open</p> <p>1——Close</p>					

Table 6.2.6 Sensor function communication object table

**6.2.7. Communication Object of current/energy metering**

Numb	Name	Object Function	Description	Group Address	Length	C	R	W	T	U	Data Type	Priority
311	KNX: Channel 1	Current value			2 bytes	C	-	W	T	U	current (mA)	Low
313	KNX: Channel 1	Power value			2 bytes	C	-	W	T	U	power (kW)	Low
311	KNX: Channel 1	Current value			4 bytes	C	-	W	T	U	electric current (A)	Low
313	KNX: Channel 1	Power value			4 bytes	C	-	W	T	U	power (W)	Low

**Current metering**

Numb	Name	Object Function	Description	Group Address	Length	C	R	W	T	U	Data Type	Priority
311	KNX: Channel 1	Current value			2 bytes	C	-	W	T	U	current (mA)	Low
312	KNX: Channel 1	Voltage value			2 bytes	C	-	W	T	U	voltage (mV)	Low
313	KNX: Channel 1	Power value			2 bytes	C	-	W	T	U	power (kW)	Low
314	KNX: Channel 1	Energy value			4 bytes	C	-	W	T	U	active energy (Wh)	Low
311	KNX: Channel 1	Current value			4 bytes	C	-	W	T	U	electric current (A)	Low
312	KNX: Channel 1	Voltage value			4 bytes	C	-	W	T	U	electric potential (V)	Low
313	KNX: Channel 1	Power value			4 bytes	C	-	W	T	U	power (W)	Low
314	KNX: Channel 1	Energy value			4 bytes	C	-	W	T	U	active energy (kWh)	Low

**Energy metering**

**Fig.6.2.7 Current/Energy metering function communication object**

NO.	Object Function	Name	Data Type	Flag	DPT
311	Current value	KNX: {{Channel 1}}	2byte	C,W,T,U	7.012 current(mA)
			4byte		9.021 current(mA)
					14.019 electric current(A)
<p>The communication object is used to receive the current value from the bus, updated to the APP display. Object datatype is determined by the parameter setting.</p> <p>When 2byte int is selected, display range: 0...65535mA, step value is 1mA.</p> <p>When 2byte float is selected, display range: -670760...670760mA, step value is 0.01mA.</p> <p>When 4byte is selected, display range: -99999999.9...99999999.9A, step value is 0.1A.</p>					
312	Voltage value	KNX: {{Channel 1}}	2byte	C,W,T,U	9.020 voltage(mV)
			4byte		14.027 electric potential(V)
<p>The communication object is used to receive the voltage value from the bus, updated to the APP display. Object datatype is determined by the parameter setting.</p> <p>When 2byte is selected, display range: -670760mV...670760mV, step value is 0.01mV.</p> <p>When 4byte is selected, display range: -99999999.9...99999999.9V, step value is 0.1V.</p>					
313	Power value	KNX: {{Channel 1}}	2byte	C,W,T,U	9.024 power(kW)
			4byte		14.056 power(W)
<p>The communication object is used to receive the power value from the bus, updated to the APP display. Object datatype is determined by the parameter setting.</p> <p>When 2byte is selected, display range: -670760kW...670760kW, step value is 0.01kW.</p> <p>When 4byte is selected, display range: -99999999.9...99999999.9W, step value is 0.1W.</p>					

<b>314</b>	<b>Energy value</b>	<b>KNX: {{Channel 1}}</b>	<b>4byte</b>	<b>C,W,T,U</b>	<b>13.010 active energy(Wh)</b> <b>13.013 active energy(kWh)</b>
<p>The communication object is used to receive the energy value from the bus, updated to the APP display. Object datatype is determined by the parameter setting.</p> <p>Display range: -2147483648...2147483647Wh, step value is 1Wh.</p> <p>Display range: -2147483648...2147483647kWh, step value is 1kWh.</p>					

Table 6.2.7 Current/Energy metering function communication object table

### 6.3. “Zigbee Channel” Communication Object

Number	Name	Object Function	Description	Group Address	Length	C	R	W	T	U	Data Type	Priority
3712	Zigbee: Channel 1	VOC value			2 bytes	C	R	-	T	-	pulses	Low
3713	Zigbee: Channel 1	CO2 value			2 bytes	C	R	-	T	-	pulses	Low
3714	Zigbee: Channel 1	Formaldehyde value			2 bytes	C	R	-	T	-	pulses	Low
3712	Zigbee: Channel 1	VOC value			2 bytes	C	R	-	T	-	concentration (µg/m <sup>3</sup> )	Low
3713	Zigbee: Channel 1	CO2 value			2 bytes	C	R	-	T	-	parts/million (ppm)	Low
3714	Zigbee: Channel 1	Formaldehyde value			2 bytes	C	R	-	T	-	concentration (µg/m <sup>3</sup> )	Low
3715	Zigbee: Channel 1	Temperature value			2 bytes	C	R	-	T	-	temperature (°C)	Low
3716	Zigbee: Channel 1	Humidity value			2 bytes	C	R	-	T	-	humidity (%)	Low
Air quality sensor												
3715	Zigbee: Channel 1	Temperature value			2 bytes	C	R	-	T	-	temperature (°C)	Low
3716	Zigbee: Channel 1	Humidity value			2 bytes	C	R	-	T	-	humidity (%)	Low
Temperature and humidity sensor												
3710	Zigbee: Channel 1	Brightness(lux) value			2 bytes	C	R	-	T	-	brightness (lux)	Low
3710	Zigbee: Channel 1	Brightness(lux) value			2 bytes	C	R	-	T	-	lux (Lux)	Low
Brightness sensor												
3710	Zigbee: Channel 1	Gas concentration value			2 bytes	C	R	-	T	-	pulses	Low
3710	Zigbee: Channel 1	Gas concentration value			2 bytes	C	R	-	T	-	parts/million (ppm)	Low
3710	Zigbee: Channel 1	Gas concentration value			2 bytes	C	R	-	T	-	concentration (µg/m <sup>3</sup> )	Low
Gas sensor												
3710	Zigbee: Channel 1	Binary value			1 bit	C	R	-	T	-	switch	Low
3710	Zigbee: Channel 1	Binary value			1 bit	C	R	-	T	-	boolean	Low
3710	Zigbee: Channel 1	Alarm detect			1 bit	C	R	-	T	-	alarm	Low
3710	Zigbee: Channel 1	Presence detect			1 bit	C	R	-	T	-	occupancy	Low
3710	Zigbee: Channel 1	Window/door detect			1 bit	C	R	-	T	-	window/door	Low
I/O signal												
3710	Zigbee: Channel 1-1	Switch			1 bit	C	-	W	-	-	switch	Low
3711	Zigbee: Channel 1-2	Switch			1 bit	C	-	W	-	-	switch	Low
3712	Zigbee: Channel 1-3	Switch			1 bit	C	-	W	-	-	switch	Low
3713	Zigbee: Channel 1-1	Switch, status			1 bit	C	R	-	T	-	switch	Low
3714	Zigbee: Channel 1-2	Switch, status			1 bit	C	R	-	T	-	switch	Low
3715	Zigbee: Channel 1-3	Switch, status			1 bit	C	R	-	T	-	switch	Low
Switch												
3710	Zigbee: Channel 1	Switch			1 bit	C	-	W	-	-	switch	Low
3712	Zigbee: Channel 1	Brightness value			1 byte	C	-	W	-	-	percentage (0..100%)	Low
3713	Zigbee: Channel 1	Switch, status			1 bit	C	R	-	T	-	switch	Low
3715	Zigbee: Channel 1	Brightness, status			1 byte	C	R	-	T	-	percentage (0..100%)	Low
Switch/Dimming												

3710	Zigbee: Channel 1	Switch	1 bit	C - W - -	switch	Low
3712	Zigbee: Channel 1	RGB dimming value	3 bytes	C - W - -	RGB value 3x(0..255)	Low
3713	Zigbee: Channel 1	Switch, status	1 bit	C R - T -	switch	Low
3715	Zigbee: Channel 1	RGB brightness, status	3 bytes	C R - T -	RGB value 3x(0..255)	Low
RGB dimming						
3710	Zigbee: Channel 1	Switch	1 bit	C - W - -	switch	Low
3711	Zigbee: Channel 1	Color temperature value	2 bytes	C - W - -	absolute colour temperature (K)	Low
3712	Zigbee: Channel 1	Brightness value	1 byte	C - W - -	percentage (0..100%)	Low
3713	Zigbee: Channel 1	Switch, status	1 bit	C R - T -	switch	Low
3714	Zigbee: Channel 1	Color temperature, status	2 bytes	C R - T -	absolute colour temperature (K)	Low
3715	Zigbee: Channel 1	Brightness, status	1 byte	C R - T -	percentage (0..100%)	Low
Color temperature						
3710	Zigbee: Channel 1	Switch	1 bit	C R W T U	switch	Low
3711	Zigbee: Channel 1	Color temperature value	2 bytes	C - W - -	absolute colour temperature (K)	Low
3712	Zigbee: Channel 1	RGB dimming value	3 bytes	C - W - -	RGB value 3x(0..255)	Low
3713	Zigbee: Channel 1	Brightness value	1 byte	C - W - -	percentage (0..100%)	Low
3714	Zigbee: Channel 1	Color temperature, status	2 bytes	C R - T -	absolute colour temperature (K)	Low
3715	Zigbee: Channel 1	RGB brightness, status	3 bytes	C R - T -	RGB value 3x(0..255)	Low
3716	Zigbee: Channel 1	Brightness, status	1 byte	C R - T -	percentage (0..100%)	Low
RGBCW						
3710	Zigbee: Channel 1-1	Open/Close	1 bit	C - W - -	open/close	Low
3711	Zigbee: Channel 1-1	Stop	1 bit	C - W - -	step	Low
3712	Zigbee: Channel 1-1	Curtain position & status	1 byte	C R W T -	percentage (0..100%)	Low
3713	Zigbee: Channel 1-2	Open/Close	1 bit	C - W - -	open/close	Low
3714	Zigbee: Channel 1-2	Stop	1 bit	C - W - -	step	Low
3715	Zigbee: Channel 1-2	Curtain position & status	1 byte	C R W T -	percentage (0..100%)	Low
Curtain position						
3710	Zigbee: Channel 1	Brightness(lux) value	2 bytes	C R - T -	lux (Lux)	Low
3715	Zigbee: Channel 1	Temperature value	2 bytes	C R - T -	temperature (°C)	Low
3716	Zigbee: Channel 1	Humidity value	2 bytes	C R - T -	humidity (%)	Low

Temperature, humidity and brightness sensor

Fig.6.3 “Zigbee Channel” communication object

NO.	Object Function	Name	Data Type	Flag	DPT
3712	VOC value	Zigbee: {{Channel 1}}	2byte	C,R,T	7.001 pulse 9.030 concentration(ug/m3)
The communication object applies to air quality sensor, is used to send the VOC value in ug/m <sup>3</sup> to the KNX bus. Range: 0...999ug/m <sup>3</sup> , object datatype is determined by the parameter setting.					
3713	CO2 value	Zigbee: {{Channel 1}}	2byte	C,R,T	7.001 pulse 9.008 parts/million(ppm)
The communication object applies to air quality sensor, is used to send the CO2 value in ppm to the KNX bus. Range: 0...4000ppm					
3714	Formaldehyde value	Zigbee: {{Channel 1}}	2byte	C,R,T	7.001 pulse 9.030 concentration(ug/m3)
The communication object applies to air quality sensor, is used to send the formaldehyde value in ug/m <sup>3</sup> to the KNX bus. Range: 0...1000ug/m <sup>3</sup>					
3715	Temperature value	Zigbee: {{Channel 1}}	2byte	C,R,T	9.001 temperature
The communication object applies to temperature sensor, and temperature, humidity and brightness sensor, is used to send the temperature value in °C to the KNX bus. Range: -50...99°C					

3716	Humidity value	Zigbee: {{Channel 1}}	2byte	C,R,T	9.007 humidity
<p>The communication object applies to humidity sensor, and temperature, humidity and brightness sensor, air quality sensor, is used to send the humidity value in % to the KNX bus. Range: 0...100%</p>					
3710	Brightness(lux) value	Zigbee: {{Channel 1}}	2byte	C,R,T	7.013 brightness(lux) 9.004 lux(lux)
<p>The communication object applies to brightness sensor, and temperature, humidity and brightness sensor, air quality sensor, is used to send the brightness value to the KNX bus. Range: 0...65535lux, object datatype is determined by the parameter setting.</p>					
3710	Gas concentration value	Zigbee: {{Channel 1}}	2byte	C,R,T	7.001 pulse 9.008 parts/million(ppm) 9.030 concentration(ug/m3)
<p>The communication object applies to gas sensor, air quality sensor, gas measurement, is used to send the gas concentration value to the KNX bus. For example VOC, CO2 or formaldehyde detection value.</p>					
3710	Binary value	Zigbee: {{Channel 1}}	1bit	C,R,T	1.001 switch 1.002 boolean
3710	Alarm detect	Zigbee: {{Channel 1}}	1bit	C,R,T	1.005 alarm
3710	Presence detect	Zigbee: {{Channel 1}}	1bit	C,R,T	1.018 occupancy
3710	Window/door detect	Zigbee: {{Channel 1}}	1bit	C,R,T	1.019 window/door
<p>The communication object applies to I/O type sensor, is used to send the I/O signal to the KNX bus. Object datatype is determined by the parameter setting. Telegram value:</p> <p style="padding-left: 40px;">0——Open/No alarm/Not occupied/Close window</p> <p style="padding-left: 40px;">1——Close/Alarm/Occupied/Open window</p>					
3710/./ 3712	Switch	Zigbee: {{Channel 1}}	1bit	C,W C,W,R,T,U	1.001 switch
3713/./ 3715	Switch, status	Zigbee: {{Channel 1}}	1bit	C,R,T	1.001 switch
<p>These communication objects apply to switch, dimming, RGB, color temperature and RGBCW control, are used for KNX system to control Zigbee lamps, including lamp, dimmable lamp, RGB bulb/strip, color temperature light and RGBCW bulb.</p> <p>When “Switch” is selected, object name is “Zigbee: {{Channel 1}}-x”, and set the number of channels for the switch by parameter, up to 3 channels, x=1/2/3.</p> <p>Telegram value:</p>					



0——Turn off the light

1——Turn on the light

Obj.3710/./3712: Used for receiving On/Off telegram from KNX bus, to control the light on/off.

When “RGBCW” is selected, object flag is C,W,R,T,U; while other selections, the object flag is C,W.

Obj.3713/./3715: Used for sending On/Off status to the bus.

3712	<b>Brightness value</b>	Zigbee: {{Channel 1}}	1byte	C,W	5.001 percentage(0..100%)
3715	<b>Brightness, status</b>	Zigbee: {{Channel 1}}	1byte	C,R,T	5.001 percentage(0..100%)

These two communication objects apply to color temperature and RGBCW control, are used for KNX system to control Zigbee lamps, including RGB bulb/strip and RGBCW bulb. Telegrams: 0...100%

Obj.3712: Used for receiving the brightness value from KNX bus, to control the brightness of the lamp.

Obj.3715: Used for sending the brightness status to KNX bus.

3712	<b>RGB dimming value</b>	Zigbee: {{Channel 1}}	3byte	C,W	232.600 RGB value 3x(0..255)
3715	<b>RGB brightness, status</b>	Zigbee: {{Channel 1}}	3byte	C,R,T	232.600 RGB value 3x(0..255)

These two communication objects apply to RGB and RGBCW control, are used for KNX system to control Zigbee lamps, including RGB bulb/strip and RGBCW bulb.

Obj.3712: Used for receiving the brightness value of RGB three-color lamp from KNX bus, to control the color of the lamp.

Obj.3715: Used for sending the brightness status of RGB three-color lamp to the KNX bus.

3-Byte Code for RGB Dimming Object Data Type: U8 U8 U8, as follows:

3 <sub>MSB</sub>	2	1 <sub>LSB</sub>
R	G	B
UUUUUUUU	UUUUUUUU	UUUUUUUU

R: red dimming value; G: green dimming value; B: blue dimming value.

3711	<b>Color temperature value</b>	Zigbee: {{Channel 1}}	2byte	C,W	7.600 absolute color temperature
3714	<b>Color temperature, status</b>	Zigbee: {{Channel 1}}	2byte	C,R,T	7.600 absolute color temperature

These two communication objects apply to color temperature and RGBCW control, are used for KNX system to control Zigbee lamps, including color temperature light and RGBCW bulb. Telegrams: 2000..7000K

Obj.3711: Used for receiving the color temperature control value form the bus, to control the color temperature of the lamp.

Obj.3714: Used for sending the color temperature status to the KNX bus.

3710/ 3713	Open/Close	Zigbee: {{Channel 1}}-x	1bit	C,W	1.009 open/close
3711/ 3714	Stop	Zigbee: {{Channel 1}}-x	1bit	C,W	1.007 step
3712/ 3715	Curtain position & status	Zigbee: {{Channel 1}}-x	1byte	C,W,R,T	5.001 percentage

These communication objects apply to curtain step/move, are used for KNX system to control Zigbee electric curtain. Set the number of channels for the curtain by parameter, up to 2 channels, x=1/2.

Obj.3710/3713: Used for receiving the telegrams from KNX bus to control curtain open/close. Telegrams:

1——Close the curtain

0——Open the curtain

Obj.3711/3714: Used for receiving the telegrams from KNX bus to stop curtain movement. Telegrams:

1——Stop

Obj.3712/3715: Used for receiving the telegrams from KNX bus to control curtain position, and return the status to bus. Telegrams: 0..100%

Table 6.3 “Zigbee Channel” communication object table

### 6.4. “Room temperature controller” Communication Object

Numb	Name	Object Function	Description	Group Address	Length	C	R	W	T	U	Data Type	Priority
74	RTC 1	Power on/off			1 bit	C	-	W	-	-	switch	Low
75	RTC 1	Room temperature sensor			2 bytes	C	-	W	T	U	temperature (°C)	Low
76	RTC 1	Current setpoint adjustment			2 bytes	C	-	W	-	-	temperature (°C)	Low
77	RTC 1	Heating/Cooling mode			1 bit	C	-	W	-	-	cooling/heating	Low
78	RTC 1	Operation mode			1 byte	C	-	W	-	-	HVAC mode	Low
79	RTC 1	Comfort mode			1 bit	C	-	W	-	-	enable	Low
80	RTC 1	Economy mode			1 bit	C	-	W	-	-	enable	Low
81	RTC 1	Frost/Heat protection mode			1 bit	C	-	W	-	-	enable	Low
82	RTC 1	Standby mode			1 bit	C	-	W	-	-	enable	Low
83	RTC 1	Fan automatic operation			1 bit	C	-	W	-	-	enable	Low
84	RTC 1	Window contact			1 bit	C	-	W	-	U	window/door	Low
85	RTC 1	Presence detector			1 bit	C	-	W	-	U	occupancy	Low
86	RTC 1	Current temperature setpoint, status			2 bytes	C	R	-	T	-	temperature (°C)	Low
87	RTC 1	Heating/Cooling mode, status			1 bit	C	R	-	T	-	cooling/heating	Low
88	RTC 1	Operation mode, status			1 byte	C	R	-	T	-	HVAC mode	Low
89	RTC 1	Comfort mode, status			1 bit	C	R	-	T	-	enable	Low
90	RTC 1	Economy mode, status			1 bit	C	R	-	T	-	enable	Low
91	RTC 1	Frost/Heat protection mode, status			1 bit	C	R	-	T	-	enable	Low
92	RTC 1	Standby mode, status			1 bit	C	R	-	T	-	enable	Low
93	RTC 1	Heating control value, status			1 bit	C	R	-	T	-	switch	Low
94	RTC 1	Cooling control value, status			1 bit	C	R	-	T	-	switch	Low
95	RTC 1	Fan speed, status			1 byte	C	-	-	T	-	percentage (0..100%)	Low

Fig.6.4 “Room temperature controller” communication object

NO.	Object Function	Name	Data Type	Flag	DPT
<b>74</b>	<b>Power on/off</b>	<b>RTC 1</b>	<b>1bit</b>	<b>C,W</b>	<b>1.001 switch</b>
<p>The communication object is used to receive the telegram value of control RTC power on/off from the bus. Telegrams:</p> <p style="text-align: center;">1—On 0—Off</p>					
<b>75</b>	<b>Room temperature sensor</b>	<b>RTC 1</b>	<b>2byte</b>	<b>C,W,T,U</b>	<b>9.001 temperature</b>
<p>The communication object is used to receive the room temperature from the bus, and send read request cyclically, and also receive feedback.</p>					
<b>76</b>	<b>Current setpoint adjustment</b>	<b>RTC 1</b>	<b>2byte</b>	<b>C,W</b>	<b>9.001 temperature</b>
<p>The communication object is used to modify the current setpoint value of temperature. Telegrams: 0..65535</p>					
<b>77</b>	<b>Heating/Cooling mode</b>	<b>RTC 1</b>	<b>1bit</b>	<b>C,W</b>	<b>1.100 cooling/heating</b>
<p>The communication object is used to switch heating/cooling mode via the bus. Telegrams:</p> <p style="text-align: center;">1—Heating 0—Cooling</p>					



78	Operation mode	RTC 1	1byte	C,W	20.102 HVAC mode
79	Comfort mode	RTC 1	1bit	C,W	1.003 enable
80	Economy mode	RTC 1	1bit	C,W	1.003 enable
81	Frost/Heat protection mode	RTC 1	1bit	C,W	1.003 enable
82	Standby mode	RTC 1	1bit	C,W	1.003 enable
<p>These communication objects are used to control RTC operation mode via the bus.</p> <p>1byte: object 78 is visible. Telegrams: 1-comfort, 2-standby, 3-economy, 4-protection, other reserved.</p> <p>1bit:</p> <p>Object 79——Comfort mode</p> <p>Object 80——Economy mode</p> <p>Object 81——Protection mode</p> <p>Object 82——Standby mode</p> <p>Activate corresponding mode when receive a telegram “1”. When 1bit standby mode is not enable, and objects value of comfort, economy and protection are all 0, it is standby mode. When 1bit standby mode is enable, the 1bit standby object receives 1 is standby mode, and telegram “0” will be ignored.</p>					
83	Fan automatic operation	RTC 1	1bit	C,W	1.003 enable
<p>The communication object is used to activate fan automatic control via the bus. Telegrams:</p> <p>1——Auto</p> <p>0——Exit auto</p>					
84	Window contact	RTC 1	1bit	C,W,U	1.019 Window/door
<p>The communication object is used to receive the switch status of window contact. Telegrams:</p> <p>1——Open window</p> <p>0——Close window</p>					
85	Presence detector	RTC 1	1bit	C,W,U	1.018 occupancy
<p>The communication object is used to receive the room occupancy status from presence detector. Telegrams:</p> <p>1——Occupied</p> <p>0——Not occupied</p>					
86	Current temperature setpoint, status	RTC 1	2byte	C,R,T	9.001 temperature
<p>The communication object is used to send the current setpoint temperature of RTC to the bus.</p> <p>Telegrams: 0..65535</p>					

87	Heating/Cooling mode, status	RTC 1	1bit	C,R,T	1.100 cooling/heating
<p>The communication object is used to feedback the telegram to the bus for switching heating and cooling function.</p>					
88	Operation mode, status	RTC 1	1byte	C,R,T	20.102 HVAC mode
89	Comfort mode, status	RTC 1	1bit	C,R,T	1.003 enable
90	Economy mode, status	RTC 1	1bit	C,R,T	1.003 enable
91	Frost/Heat protection mode, status	RTC 1	1bit	C,R,T	1.003 enable
92	Standby mode, status	RTC 1	1bit	C,R,T	1.003 enable
<p>These communication objects are used to send RTC operation mode status to the bus.</p> <p>When 1 byte: object 88 is visible, telegrams: 1-comfort, 2-standby, 3-economy, 4-protection, other reserved.</p> <p>When 1bit:</p> <ul style="list-style-type: none"> <li>Object 89—— Comfort mode</li> <li>Object 90—— Economy mode</li> <li>Object 91—— Protection mode</li> <li>Object 92—— Standby mode</li> </ul> <p>When a mode is activated, the corresponding object only sends telegram “1”. When 1 bit standby object is not enable, activate standby mode when comfort, economy, protection objects send telegram 0 together. When 1 bit standby object is enable, activate standby mode only when standby object send 1.</p> <p><b>Note: no requirement to send mode status to the bus when switchover via bus. The same is fan speed and other operation.</b></p>					
93	Heating control value, status	RTC 1	1bit 1byte	C,R,T	1.001 switch 5.001 percentage
94	Cooling control value, status	RTC 1	1bit 1byte	C,R,T	1.001 switch 5.001 percentage
<p>These communication objects are used to send control status of heating or cooling function to the bus. Object datatype is according to parameter setting.</p>					
94	Fan speed, status	RTC 1	1byte	C,T	5.001 percentage 5.100 fan stage
<p>The communication object is used to send the status of fan speed to the bus. The corresponding telegram value of each fan speed is defined by the parameter.</p>					

Table 6.4 “Room temperature controller” communication object table

### 6.5. “Ventilation controller” Communication Object

Numb	Name	Object Function	Description	Group Address	Length	C	R	W	T	U	Data Type	Priority
294	Ventilation controller	Fan automatic operation			1 bit	C	-	W	-	-	enable	Low
295	Ventilation controller	PM 2.5 value			2 bytes	C	-	W	T	U	pulses	Low
296	Ventilation controller	Fan speed, status			1 byte	C	-	-	T	-	percentage (0..100%)	Low
297	Ventilation controller	Fan speed low, status			1 bit	C	-	-	T	-	switch	Low
298	Ventilation controller	Fan speed medium, status			1 bit	C	-	-	T	-	switch	Low
299	Ventilation controller	Fan speed high, status			1 bit	C	-	-	T	-	switch	Low

Fig.6.5 “Ventilation controller” communication object

NO.	Object Function	Name	Data Type	Flag	DPT
294	Fan automatic operation	Ventilation controller	1bit	C,W	1.003 enable
<p>The communication object is used to activate fan automatic control via the bus. Telegrams:</p> <p>1——Auto</p> <p>0——Exit auto</p>					
295	PM 2.5 value VOC value CO2 value	Ventilation controller	2byte	C,W,T,U	7.001 pulse 9.030 concentration(ug/m3) 9.008 parts/million(ppm)
<p>The communication object is used to receive the input value of PM2.5/VOC/CO2, and get the corresponding value from the bus and update it to the display, the corresponding object datatype is defined by the parameter. Unit is ug/m<sup>3</sup> or ppm. Range: 0~999ug/m<sup>3</sup> or 0..4000ppm</p> <p>For example, Control value of automatic operation is PM2.5, that is, under the automation, the ventilation system can adjust the fan speed automatically according to PM2.5 concentration.</p>					
296	Fan speed, status	Ventilation controller	1byte	C,T	5.001 percentage 5.100 fan stage
297	Fan speed low, status	Ventilation controller	1bit	C,T	1.001 switch
298	Fan speed medium, status	Ventilation controller	1bit	C,T	1.001 switch
299	Fan speed high, status	Ventilation controller	1bit	C,T	1.001 switch
<p>These communication objects are used to send control telegrams of the fan speed to the bus.</p> <p>1byte: the corresponding telegram value of each fan speed is defined by the parameter. Object 296 sends the corresponding telegram value of the fan speed to the bus.</p> <p>1bit:</p> <p>Object 297——Low fan speed</p> <p>Object 298——Medium fan speed</p> <p>Object 299——High fan speed</p> <p>The corresponding object sends telegram “1” to the bus, and sends telegram “0” is turn off fan speed.</p>					

Table 6.5 “Ventilation controller” communication object table

## 6.6. “Logic” Communication Object

### 6.6.1. “AND/OR/XOR” Communication Object

Numb	Name	Object Function	Description	Group Address	Length	C	R	W	T	U	Data Type	Priority
2	1st Logic	Input a			1 bit	C	-	W	T	U	boolean	Low
3	1st Logic	Input b			1 bit	C	-	W	T	U	boolean	Low
4	1st Logic	Input c			1 bit	C	-	W	T	U	boolean	Low
5	1st Logic	Input d			1 bit	C	-	W	T	U	boolean	Low
6	1st Logic	Input e			1 bit	C	-	W	T	U	boolean	Low
7	1st Logic	Input f			1 bit	C	-	W	T	U	boolean	Low
8	1st Logic	Input g			1 bit	C	-	W	T	U	boolean	Low
9	1st Logic	Input h			1 bit	C	-	W	T	U	boolean	Low
10	1st Logic	Logic result			1 bit	C	-	-	T	-	boolean	Low

Fig.6.6.1 “AND/OR/XOR” Communication Object

NO.	Object Function	Name	Data Type	Flag	DPT
2/...	<b>Input x</b>	<b>1st /.../8th Logic</b>	<b>1bit</b>	<b>C,W,T,U</b>	<b>1.002 boolean</b>
The communication object is used to receive the value of logical input Input x.					
10	<b>Logic result</b>	<b>1st /.../8th Logic</b>	<b>1bit</b>	<b>C,T</b>	<b>1.002 boolean</b>
The communication object is used to send the results of logical operation.					

Table 6.6.1 “AND/OR/XOR” communication object table

### 6.6.2. “Gate forwarding” Communication Object

Numb	Name	Object Function	Description	Group Address	Length	C	R	W	T	U	Data Type	Priority
2	1st Logic	Gate value select			1 byte	C	-	W	-	-	scene number	Low
3	1st Logic	Input A			1 bit	C	-	W	-	-	switch	Low
4	1st Logic	Input B			1 bit	C	-	W	-	-	switch	Low
5	1st Logic	Input C			1 bit	C	-	W	-	-	switch	Low
6	1st Logic	Input D			1 bit	C	-	W	-	-	switch	Low
7	1st Logic	Output A			1 bit	C	-	-	T	-	switch	Low
8	1st Logic	Output B			1 bit	C	-	-	T	-	switch	Low
9	1st Logic	Output C			1 bit	C	-	-	T	-	switch	Low
10	1st Logic	Output D			1 bit	C	-	-	T	-	switch	Low

Fig.6.6.2 “Gate forwarding” Communication Object

NO.	Object Function	Name	Data Type	Flag	DPT
2	<b>Gate value select</b>	<b>1st /.../8th Logic</b>	<b>1byte</b>	<b>C,W</b>	<b>17.001 scene number</b>
The communication object is used to select the scene of logical gate forwarding.					
3/.../6	<b>Input x</b>	<b>1st /.../8th Logic</b>	<b>1bit</b> <b>4bit</b> <b>1byte</b>	<b>C,W</b>	<b>1.001 switch</b> <b>3.007 dimming control</b> <b>5.010 counter pulses(0..255)</b>
The communication object is used to receive the value of the logic gate input Input x.					

7/.../10	Output x	1st /.../8th Logic	1bit 4bit 1byte	C,T	1.001 switch 3.007 dimming control 5.010 counter pulses(0..255)
<p>The communication object is used to output the value forwarded by the logic gate. The output value is the same as the input value, but one input can be forwarded into one or more outputs, set by parameters.</p>					

Table 6.6.2 “Gate forwarding” communication object table

### 6.6.3. “Threshold comparator” Communication Object

Numb	Name	Object Function	Description	Group Address	Length	C	R	W	T	U	Data Type	Priority
2	1st Logic	Threshold value input			4 bit	C	-	W	-	U	dimming control	Low
2	1st Logic	Threshold value input			1 byte	C	-	W	-	U	counter pulses (0..255)	Low
2	1st Logic	Threshold value input			2 bytes	C	-	W	-	U	pulses	Low
2	1st Logic	Threshold value input			4 bytes	C	-	W	-	U	counter pulses (unsigned)	Low
10	1st Logic	Logic result			1 bit	C	-	-	T	-	boolean	Low

Fig.6.6.3 “Threshold comparator” Communication Object

NO.	Object Function	Name	Data Type	Flag	DPT
2	Threshold value input	1st /.../8th Logic	4bit 1byte 2byte 4byte	C,W, U	3.007 dimming control 5.010 counter pulses(0..255) 7.001 pulses 12.001 counter pulses
<p>The communication object is used to input threshold value.</p>					
10	Logic result	1st /.../8th Logic	1bit	C,T	1.002 boolean
<p>The communication object is used to send the results of logical operation. That is, the value that should be sent after the object input threshold is compared with the setting threshold value.</p>					

Table 6.6.3 “Threshold comparator” communication object table

### 6.6.4. “Format convert” Communication Object

Numb	Name	Object Function	Description	Group Address	Length	C	R	W	T	U	Data Type	Priority
2	1st Logic	Input 1bit-bit0			1 bit	C	-	W	-	U	boolean	Low
3	1st Logic	Input 1bit-bit1			1 bit	C	-	W	-	U	boolean	Low
10	1st Logic	Output 2bit			2 bit	C	-	-	T	-	switch control	Low

“2x1bit --> 1x2bit”function: converts two 1bit values to a 2bit value, such as Input bit1=1, bit0=0--> Output 2bit=2

Num	Name	Object Function	Description	Group Address	Length	C	R	W	T	U	Data Type	Priority
2	1st Logic	Input 1bit-bit0			1 bit	C	-	W	-	U	boolean	Low
3	1st Logic	Input 1bit-bit1			1 bit	C	-	W	-	U	boolean	Low
4	1st Logic	Input 1bit-bit2			1 bit	C	-	W	-	U	boolean	Low
5	1st Logic	Input 1bit-bit3			1 bit	C	-	W	-	U	boolean	Low
6	1st Logic	Input 1bit-bit4			1 bit	C	-	W	-	U	boolean	Low
7	1st Logic	Input 1bit-bit5			1 bit	C	-	W	-	U	boolean	Low
8	1st Logic	Input 1bit-bit6			1 bit	C	-	W	-	U	boolean	Low
9	1st Logic	Input 1bit-bit7			1 bit	C	-	W	-	U	boolean	Low
10	1st Logic	Output 1byte			1 byte	C	-	-	T	-	counter pulses (0..255)	Low

“8x1bit --> 1x1byte”function: converts eight 1bit values to a 1byte value, such as Input bit2=1, bit1=1, bit0=1, other bits are 0--> Output 1byte=7

Num	Name	Object Function	Description	Group Address	Length	C	R	W	T	U	Data Type	Priority
2	1st Logic	Input 1byte			1 byte	C	-	W	-	U	counter pulses (0..255)	Low
10	1st Logic	Output 2byte			2 bytes	C	-	-	T	-	pulses	Low

“1x1byte --> 1x2byte”function: converts one 1byte values to a 2byte value, such as Input 1byte=125--> Output 2byte=125. Although the value remains the same, the data type of the value is different.

Num	Name	Object Function	Description	Group Address	Length	C	R	W	T	U	Data Type	Priority
2	1st Logic	Input 1byte-low			1 byte	C	-	W	-	U	counter pulses (0..255)	Low
3	1st Logic	Input 1byte-high			1 byte	C	-	W	-	U	counter pulses (0..255)	Low
10	1st Logic	Output 2byte			2 bytes	C	-	-	T	-	pulses	Low

“2x1byte --> 1x2byte”function: converts two 1byte values to a 2byte value, such as Input 1byte-low = 255 (\$FF), Input 1byte-high = 100 (\$64) --> Output 2byte = 25855 (\$64 FF)

Num	Name	Object Function	Description	Group Address	Length	C	R	W	T	U	Data Type	Priority
2	1st Logic	Input 2byte-low			2 bytes	C	-	W	-	U	pulses	Low
3	1st Logic	Input 2byte-high			2 bytes	C	-	W	-	U	pulses	Low
10	1st Logic	Output 4byte			4 bytes	C	-	-	T	-	counter pulses (unsigned)	Low

“2x2byte --> 1x4byte”function: converts two 2 byte values to a 4byte value, such as Input 2byte-low = 65530 (\$FF FA), Input 2byte-high = 32768 (\$80 00)--> Output 2byte = 2147549178 (\$80 00 FF FA)

Num	Name	Object Function	Description	Group Address	Length	C	R	W	T	U	Data Type	Priority
2	1st Logic	Input 1byte			1 byte	C	-	W	-	U	counter pulses (0..255)	Low
3	1st Logic	Output 1bit-bit0			1 bit	C	-	-	T	-	boolean	Low
4	1st Logic	Output 1bit-bit1			1 bit	C	-	-	T	-	boolean	Low
5	1st Logic	Output 1bit-bit2			1 bit	C	-	-	T	-	boolean	Low
6	1st Logic	Output 1bit-bit3			1 bit	C	-	-	T	-	boolean	Low
7	1st Logic	Output 1bit-bit4			1 bit	C	-	-	T	-	boolean	Low
8	1st Logic	Output 1bit-bit5			1 bit	C	-	-	T	-	boolean	Low
9	1st Logic	Output 1bit-bit6			1 bit	C	-	-	T	-	boolean	Low
10	1st Logic	Output 1bit-bit7			1 bit	C	-	-	T	-	boolean	Low

“1x1byte --> 8x1bit” function: converts one 1byte values to eight 1bit value, such as Input 1byte=200 --> Output bit0=0, bit1=0, bit2=0, bit3=1, bit4=0, bit5=0, bit6=1, bit7=1

Num	Name	Object Function	Description	Group Address	Length	C	R	W	T	U	Data Type	Priority
2	1st Logic	Input 2byte			2 bytes	C	-	W	-	U	pulses	Low
9	1st Logic	Output 1byte-low			1 byte	C	-	-	T	-	counter pulses (0..255)	Low
10	1st Logic	Output 1byte-high			1 byte	C	-	-	T	-	counter pulses (0..255)	Low

“1x2byte --> 2x1byte”function: converts one 2byte values to two 2byte value, such as Input 2byte = 55500 (\$D8 CC) --> Output 1byte-low = 204 (\$CC), Output 1byte-high =216 (\$D8)



Numb	Name	Object Function	Description	Group Address	Length	C	R	W	T	U	Data Type	Priority
2	1st Logic	Input 4byte			4 bytes	C	-	W	-	U	counter pulses (unsigned)	Low
9	1st Logic	Output 2byte-low			2 bytes	C	-	-	T	-	pulses	Low
10	1st Logic	Output 2byte-high			2 bytes	C	-	-	T	-	pulses	Low

“1x4byte --> 2x2byte”function: converts one 4byte values to two 2byte value, such as Input 4byte = 78009500 (\$04 A6 54 9C) --> Output 2byte-low = 21660 (\$54 9C), Output 2byte-high =1190 (\$04 A6)

Numb	Name	Object Function	Description	Group Address	Length	C	R	W	T	U	Data Type	Priority
2	1st Logic	Input 3byte			3 bytes	C	-	W	-	U	RGB value 3x(0..255)	Low
8	1st Logic	Output 1byte-low			1 byte	C	-	-	T	-	counter pulses (0..255)	Low
9	1st Logic	Output 1byte-middle			1 byte	C	-	-	T	-	counter pulses (0..255)	Low
10	1st Logic	Output 1byte-high			1 byte	C	-	-	T	-	counter pulses (0..255)	Low

“1x3byte --> 3x1byte”function: converts one 3byte values to three 1byte value, such as Input 3byte = \$78 64 C8--> Output 1byte-low = 200 (\$C8) , Output 1byte-middle = 100 (\$64) , Output 1byte-high =120 (\$78)

Numb	Name	Object Function	Description	Group Address	Length	C	R	W	T	U	Data Type	Priority
2	1st Logic	Input 1byte-low			1 byte	C	-	W	-	U	counter pulses (0..255)	Low
3	1st Logic	Input 1byte-middle			1 byte	C	-	W	-	U	counter pulses (0..255)	Low
4	1st Logic	Input 1byte-high			1 byte	C	-	W	-	U	counter pulses (0..255)	Low
10	1st Logic	Output 3byte			3 bytes	C	-	-	T	-	RGB value 3x(0..255)	Low

“3x1byte --> 1x3byte”function: converts three 1byte values to a 3byte value, such as Input 1byte-low = 150 (\$96), Input 1byte-middle = 100 (\$64), Input 1byte-high = 50 (\$32)--> Output 3byte = \$32 64 96

Fig.6.6.4 “Format convert” Communication Object

NO.	Object Function	Name	Data Type	Flag	DPT
2	Input ...	1st /.../8th Logic	1bit	C,W,U	1.001 switch
			1byte		5.010 counter pulses(0..255)
			2byte		7.001 pulses
			3byte		232.600 RGB value 3x(0..255)
			4byte		12.001 counter pulses
The communication object is used to input a value that needs to be converted.					
10	Output ...	1st /.../8th Logic	1bit	C,T	1.001 switch
			2bit		2.001 switch control
			1byte		5.010 counter pulses(0..255)
			2byte		7.001 pulses
			3byte		232.600 RGB value 3x(0..255)
4byte	12.001 counter pulses				
The communication object is used to output the converted value.					

Table 6.6.4 “Format convert” communication object table



6.6.5. “Gate function” Communication Object

Numb	Name	Object Function	Description	Group Address	Length	C	R	W	T	U	Data Type	Priority
2	1st Logic	Input			1 bit	C	-	W	-	-	switch	Low
3	1st Logic	Gate input			1 bit	C	-	W	-	-	boolean	Low
10	1st Logic	Output			1 bit	C	-	-	T	-	switch	Low
Input/Output - 1bit[On/Off]												
Numb	Name	Object Function	Description	Group Address	Length	C	R	W	T	U	Data Type	Priority
2	1st Logic	Input			1 byte	C	-	W	-	-	percentage (0..100%)	Low
3	1st Logic	Gate input			1 bit	C	-	W	-	-	boolean	Low
10	1st Logic	Output			1 byte	C	-	-	T	-	percentage (0..100%)	Low
Input/Output - 1byte[0..100%]												
Numb	Name	Object Function	Description	Group Address	Length	C	R	W	T	U	Data Type	Priority
2	1st Logic	Input			1 byte	C	-	W	-	-	counter pulses (0..255)	Low
3	1st Logic	Gate input			1 bit	C	-	W	-	-	boolean	Low
10	1st Logic	Output			1 byte	C	-	-	T	-	counter pulses (0..255)	Low
Input/Output - 1byte[0..255]												
Numb	Name	Object Function	Description	Group Address	Length	C	R	W	T	U	Data Type	Priority
2	1st Logic	Input			2 bytes	C	-	W	-	-	temperature (°C)	Low
3	1st Logic	Gate input			1 bit	C	-	W	-	-	boolean	Low
10	1st Logic	Output			2 bytes	C	-	-	T	-	temperature (°C)	Low
Input/Output - 2byte[Float]												
Numb	Name	Object Function	Description	Group Address	Length	C	R	W	T	U	Data Type	Priority
2	1st Logic	Input			2 bytes	C	-	W	-	-	pulses	Low
3	1st Logic	Gate input			1 bit	C	-	W	-	-	boolean	Low
10	1st Logic	Output			2 bytes	C	-	-	T	-	pulses	Low
Input/Output - 2byte[0..65535]												

Fig.6.6.5 “Gate function” Communication Object

NO.	Object Function	Name	Data Type	Flag	DPT
2	Input	1st /.../8th Logic	1bit	C,W	1.001 switch
			1byte		5.001 percentage
			2byte		5.010 counter pulses
					9.001 temperature
					7.001 pulses
The communication object is used to input a value that needs to gate filter.					
3	Gate input	1st /.../8th Logic	1bit	C,W	1.002 boolean
The communication object is used to control the switch status of gate input. Input signal is allowed to pass when gate open, then output, and the current input status is still sent if there is a change; Can not pass when gate close.					
10	Output	1st /.../8th Logic	bit	C,T	1.001 switch
			1byte		5.001 percentage
			2byte		5.010 counter pulses
					9.001 temperature
					7.001 pulses
The communication object is used to output the value after gate filtering. Only when gate input status is open, output is available, defined by the object “Gate input”.					

Table 6.6.5 “Gate function” communication object table

**6.6.6. “Delay function” Communication Object**

Numb	Name	Object Function	Description	Group Address	Length	C	R	W	T	U	Data Type	Priority
2	1st Logic	Input			1 bit	C	-	W	-	-	switch	Low
10	1st Logic	Output			1 bit	C	-	-	T	-	switch	Low
Input/Output - 1bit[On/Off]												
Numb	Name	Object Function	Description	Group Address	Length	C	R	W	T	U	Data Type	Priority
2	1st Logic	Input			1 byte	C	-	W	-	-	percentage (0..100%)	Low
10	1st Logic	Output			1 byte	C	-	-	T	-	percentage (0..100%)	Low
Input/Output - 1byte[0..100%]												
Numb	Name	Object Function	Description	Group Address	Length	C	R	W	T	U	Data Type	Priority
2	1st Logic	Input			1 byte	C	-	W	-	-	counter pulses (0..255)	Low
10	1st Logic	Output			1 byte	C	-	-	T	-	counter pulses (0..255)	Low
Input/Output - 1byte[0..255]												
Numb	Name	Object Function	Description	Group Address	Length	C	R	W	T	U	Data Type	Priority
2	1st Logic	Input			2 bytes	C	-	W	-	-	temperature (°C)	Low
10	1st Logic	Output			2 bytes	C	-	-	T	-	temperature (°C)	Low
Input/Output - 2byte[Float]												
Numb	Name	Object Function	Description	Group Address	Length	C	R	W	T	U	Data Type	Priority
2	1st Logic	Input			2 bytes	C	-	W	-	-	pulses	Low
10	1st Logic	Output			2 bytes	C	-	-	T	-	pulses	Low
Input/Output - 2byte[0..65535]												

Fig.6.6.6 “Delay function” Communication Object

NO.	Object Function	Name	Data Type	Flag	DPT
2	Input	1st /.../8th Logic	1bit	C,W	1.001 switch
			1byte		5.001 percentage
			2byte		5.010 counter pulses
					9.001 temperature
The communication object is used to input a value that needs to delay.					
10	Output	1st /.../8th Logic	1bit	C,T	1.001 switch
			1byte		5.001 percentage
			2byte		5.010 counter pulses
					9.001 temperature
The communication object is used to output that needs to delay converted value, delay time is defined by the parameter.					
					7.001 pulses

Table 6.6.6 “Delay function” communication object table

**6.6.7. “Staircase lighting” Communication Object**

Numb	Name	Object Function	Description	Group Address	Length	C	R	W	T	U	Data Type	Priority
2	1st Logic	Trigger value			1 bit	C	-	W	-	-	trigger	Low
3	1st Logic	Light-on duration time			2 bytes	C	-	W	-	-	time (s)	Low
10	1st Logic	Output			1 bit	C	-	-	T	-	switch	Low
10	1st Logic	Output			1 byte	C	-	-	T	-	counter pulses (0..255)	Low

Fig.6.6.7 “Staircase lighting” Communication Object



NO.	Object Function	Name	Data Type	Flag	DPT
<b>2</b>	<b>Trigger value</b>	<b>1st /.../8th Logic</b>	<b>1bit</b>	<b>C,W</b>	<b>1.017 trigger</b>
The communication object is used to receive the value to trigger staircase lighting.					
<b>3</b>	<b>Light-on duration time</b>	<b>1st /.../8th Logic</b>	<b>2byte</b>	<b>C,W</b>	<b>7.005 time(s)</b>
The communication object is used to modify the staircase light-on duration time, the modified range is referenced from the range defined by the parameter, take the limit value if exceeded.					
<b>10</b>	<b>Output</b>	<b>1st /.../8th Logic</b>	<b>1bit</b> <b>1byte</b>	<b>C,T</b>	<b>1.001 switch</b> <b>5.010 counter pulses</b>
The communication object is used to output value 1 when trigger, and send value 2 after duration time. Telegram value is determined by the parameter setting datatype.					

Table 6.6.7 “Staircase lighting” communication object table

## Chapter 7 UI Description for Tuya Smart APP

This chapter detail UI use for Tuya Smart APP in functional blocks. Please make sure the database is downloaded to KNX Gateway for Tuya ZigBee before operating APP. Once the database is downloaded, you can add gateways and other devices on the APP.

### 7.1. Add device

Click icon  on the mobile phone desk to start up Tuya Smart APP, register or login the account. Click the icon  in the upper right corner of homepage to add device after login successfully. Take KNX Gateway for Tuya ZigBee as an example to explain the operation of adding a device.

Other devices are added in similar ways to the gateway, and no longer repeat in this chapter.

1. Select corresponding device type, KNX Gateway for Tuya ZigBee selects the Gateway in Gateway Control. You can select to add it manually(Step 2~5), or select to click icon  to auto scan, please ensure that the device has entered paring mode, click blue word in the follow picture to go to the details of “Auto Scan”. If failed to auto add device, you can select to Try again or Add Manually.

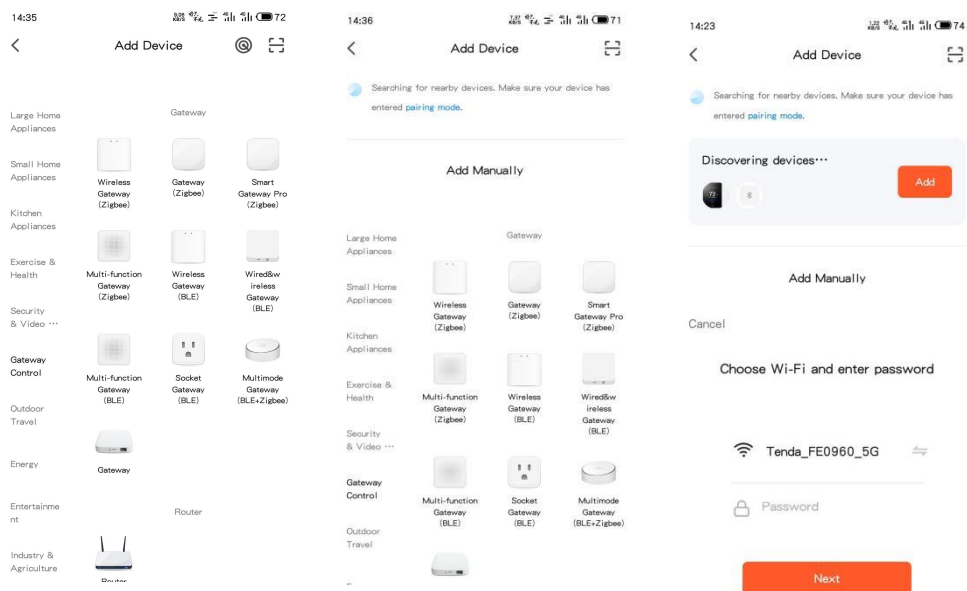

**Note:** Please ensure to turn on Bluetooth, Wi-Fi and Location services, otherwise the APP cannot

search the device, and display the following prompt:

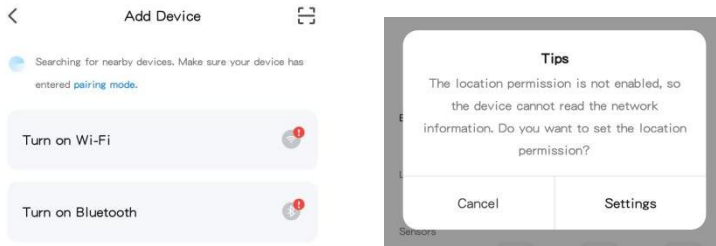

2. Click device icon, you can see the device connection steps. If the device is not reset, please perform net pairing as prompted. If it has been reset, ignore step 3. Please note the LED indication status on the gateway.

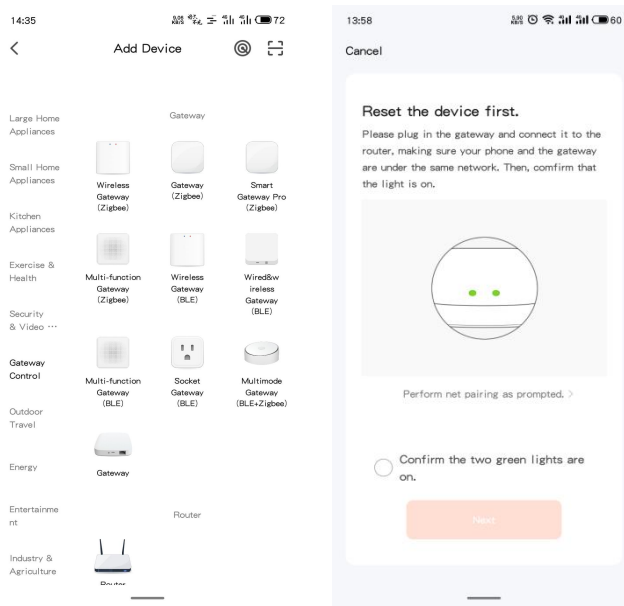

3. Reset device. Long press ZigBee connect button on the gateway for 5s, to remove the gateway from the cloud, triggered to flash after manually operating the connect button, and flashing 5 times to enter the waiting connection status. LED indication effect of gateway as follow:

LAN LED—Green LED:

——Always on after gateway network is connected OK, flashing when there is a data communication.

Connect status LED—Green LED:

——Off when gateway is connected to cloud;

——Always on when connection is waiting to connect;

——Always flashing when Tuya authorization code is abnormal(Unprogram).

4. Make sure the device reset is successful, and your phone and the gateway are under the same network. Then make sure the device LED is indicated correctly. The gateway confirms that the two green lights(Connect status LED and LAN LED) are always on, then click Next to enter the status for connecting device.

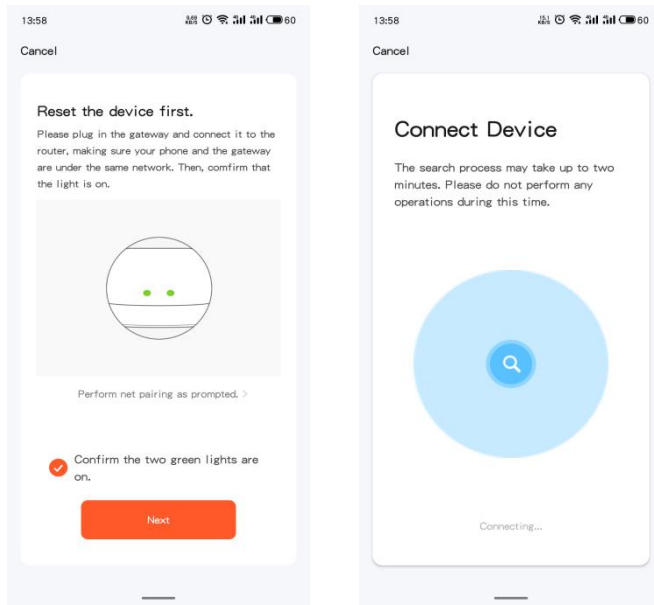

5. Add device. When scan the “KNXGateway”, click the icon  to complete the addition.

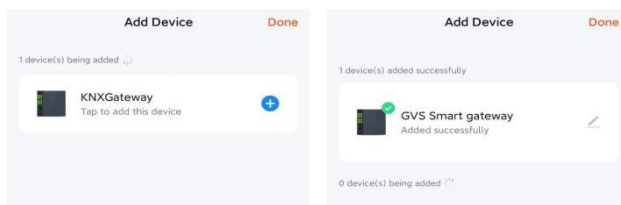

**Note: For Android systems, if the gateway fails to connect several times, it need to clear cache. Click icon  in the upper right corner of **【Me】** interface to enter the settings page, select **【Clear Cache】** .**

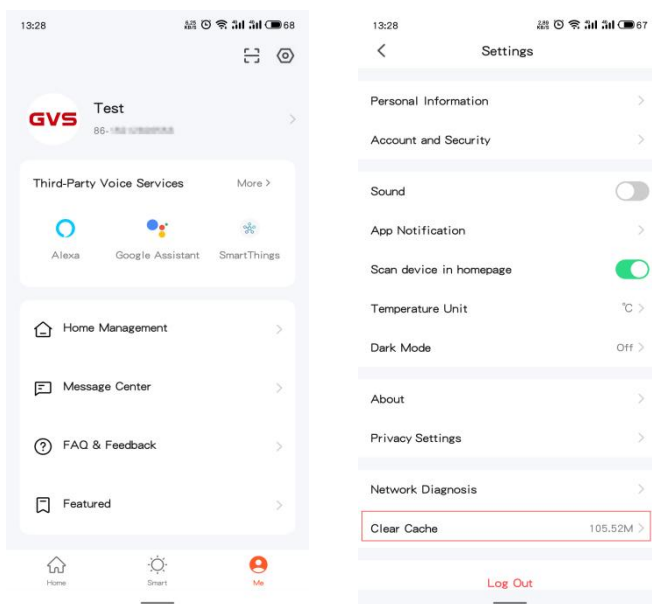

6. After completing the above steps, display setting page of the device, and displays a list of the added subdevices. Click “Add subdevice” to search device for addition.

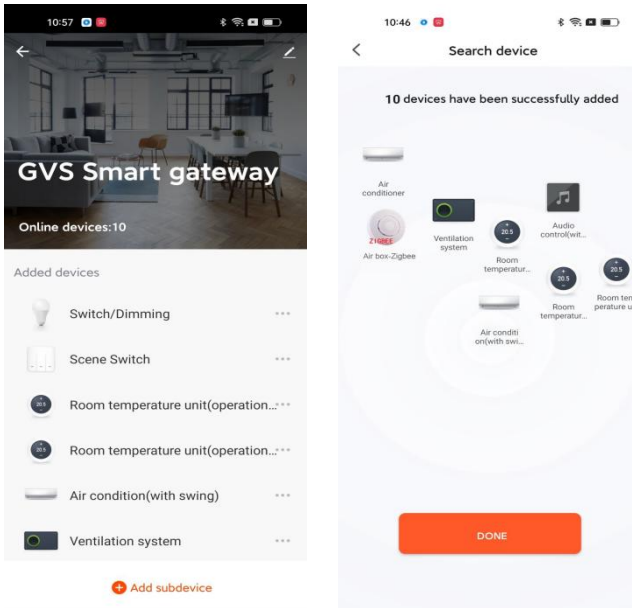

As below, the interactive use of KNX channel devices will be described in detail.



## 7.2. Switch interface

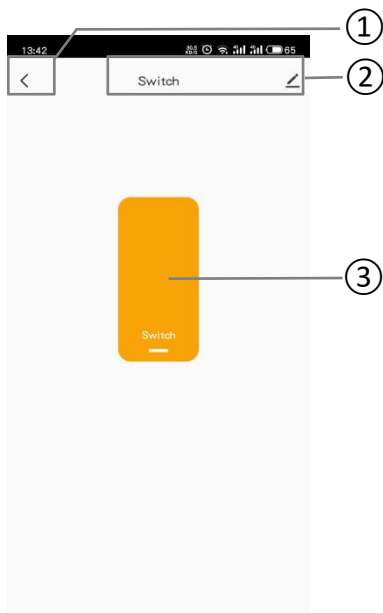

Fig.7.2(1) Switch interface

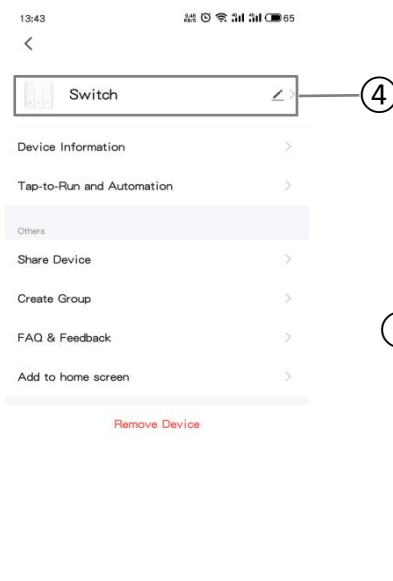

Fig.7.2(2) Device basic settings

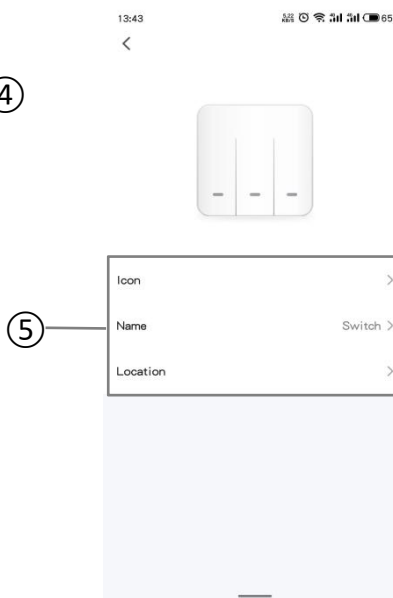



Fig.7.2(3) Info editing interface

①Return to the previous interface.

②Device name, shown it above the interface. Click icon  to go to figure7.2(2), you can view, change device settings, and remove devices.

Device basic settings as shown in figure 7.2 (2), including Device Information, Tap-to-Run and Automation, Other settings, and Remove Device. Set the Tap-to-Run and Automation via KNX scene switch, details in chapter 7.7.

Click ④ to go to figure7.2(3), you can edit current device name, icon and location.

③Switch button, gray indicates status off, bright color indicates status on. Used for switching of switch status.

### 7.3. Switch/Dimming interface

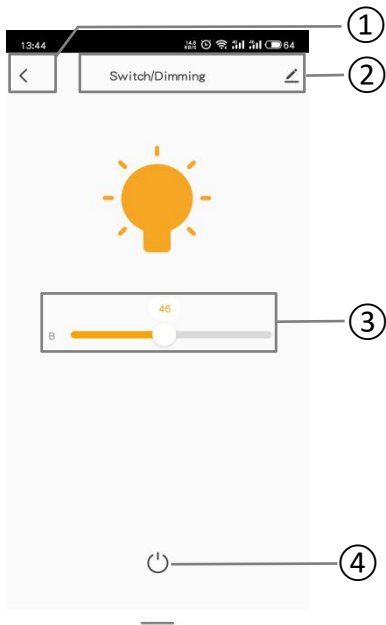



Fig.7.3(1) Switch/Dimming interface

①Return to the previous interface.

②Device name, shown it above the interface. Click icon  , you can view, change device settings, and remove devices.

③B: brightness adjustment. Adjust brightness by sliding this slider, range: 0..100%

④LED switch button, gray indicates status off, bright color indicates status on. Used for switching of switch status. When brightness value is not 0, touch this button to close brightness, and value is 0.

## 7.4. RGB Dimming interface



Fig.7.4(1) RGB dimming interface

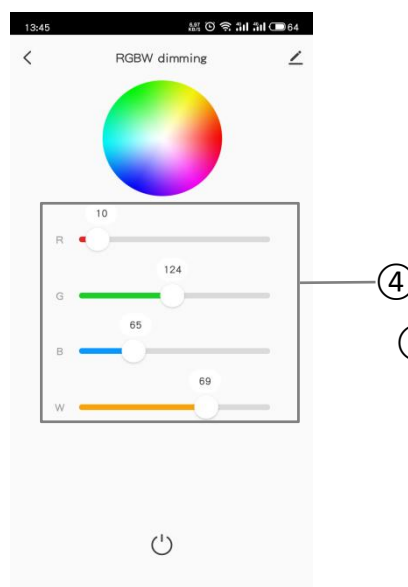

Fig.7.4(2)RGBW dimming interface

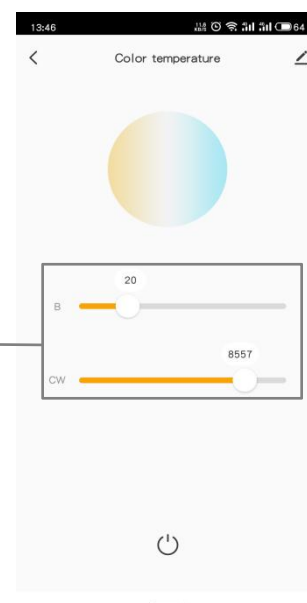



Fig.7.4(3)Color temperature interface

①Return to the previous interface.

②Device name, shown it above the interface. Click icon  , you can view, change device settings, and remove devices.

There are 3 control types of RGB dimming function: RGB, RGBW, Color Temperature. Among them, RGB is suitable for adjusting RGB lamp; RGBW is suitable for controlling RGBW strip; Color Temperature is suitable for color temperature control. Shown as figure7.4(1)(2)(3).

③RGB value adjustment. Adjust brightness by sliding R/G/B slider, range: 0..255

④RGBW value adjustment. Adjust brightness by sliding R/G/B/W slider, range: 0..255

⑤B: brightness adjustment. Adjust brightness by sliding this slider, range: 0..100%

CW: color temperature adjustment. Adjust color temperature by sliding this slider, range: 2000..7000K

⑥LED switch button, gray indicates status off, bright color indicates status on. When current value is not 0, touch this button to close R/G/B/W or B/CW, and value is 0.

### 7.5. Curtain control interface

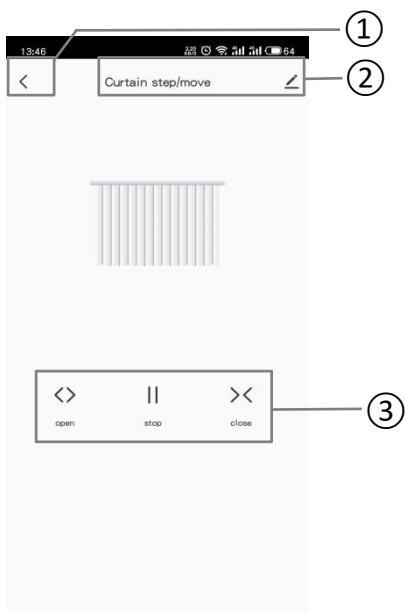

Fig.7.5(1)Curtain step/move

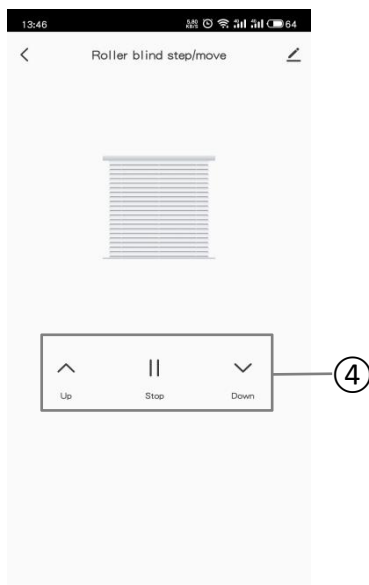

Fig.7.5(2)Roller blind step/move

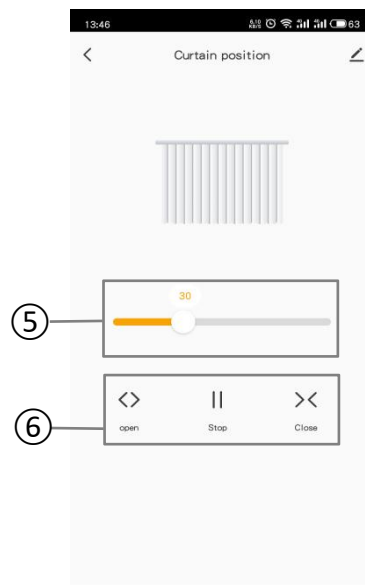

Fig.7.5(3)Curtain position

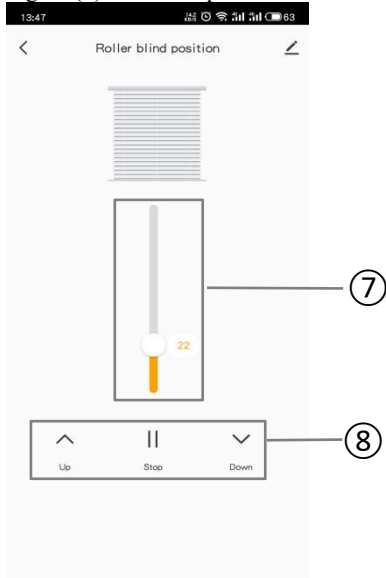

Fig.7.5(4)Roller blind position

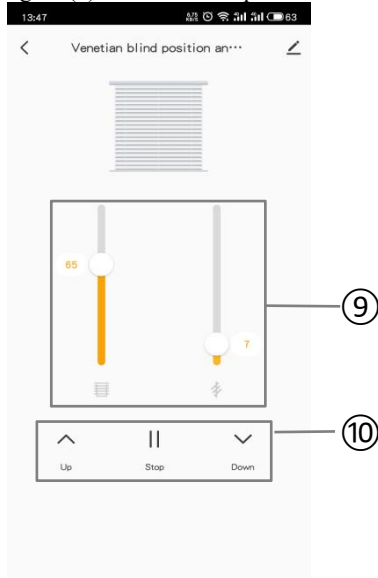





Fig.7.5(5)Venetian blind position and slat

①Return to the previous interface.

②Device name, shown it above the interface. Click icon  , you can view, change device settings, and remove devices.

③Curtain step/move:

- 1)Touch icon  , open curtain. Device sends out a telegram with the object(Open/Close) value of 0;
- 2)Touch icon  , stop curtain. Device sends out a telegram with the object(Stop) value of 1;
- 3)Touch icon  , close curtain. Device sends out a telegram with the object(Open/Close) value of 1;

④Roller blind step/move:

- 1)Touch icon  , move up blind. Device sends out a telegram with the object(Up/Down) value of 0;

2) Touch icon  , stop blind. Device sends out a telegram with the object(Stop) value of 1;

3) Touch icon  , move down blind. Device sends out a telegram with the object(Up/Down) value of 1;



⑤⑥Curtain position:

1) By sliding the slider  to adjust the position of curtain;

2)    Operation of Open/Close/Stop are the same as above.



⑦⑧Roller blind position:

1) By sliding the slider  to adjust the position of blind;

2)    Operation of Up/Down/Stop are the same as above.

⑨⑩Venetian blind position and slat:

1) By sliding the slider  to adjust the position and louver angle of venetian blind;

2)    Operation of Up/Down/Stop are the same as above.

## 7.6. Value sender interface

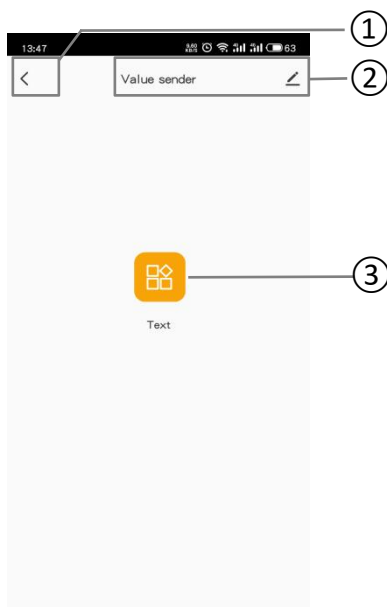



Fig.7.6Value sender

①Return to the previous interface.

②Device name, shown it above the interface. Click icon  , you can view, change device settings, and remove devices.

③Touch icon, send telegram to KNX bus. Only used to trigger calling command on the APP, with only button operation.

There are 8 value types sent: 1bit[On/Off], 2bit[0..3], 1byte[0..255], 1byte[0..100%], 1byte[scene control], 2byte[-671 088.64..670 760.96], 2byte[0..65535].

### 7.7. KNX Scene switch interface

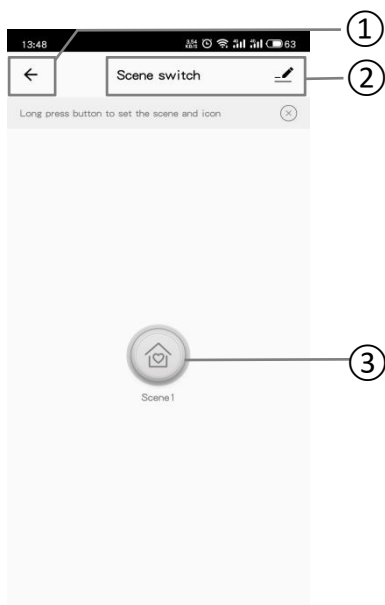



Fig.7.7(1) Scene switch interface

①Return to the previous interface.

②Device name, shown it above the interface. Click icon , you can view, change device settings, and remove devices.

③Long press to enter the scene setting, receive KNX scene calling command, or short press on the APP to perform action set in scene setting, link the KNX device functions to the ZigBee on the APP. Configure specific associated devices and trigger responses for scene on the APP before operation.

#### Add scene setting:

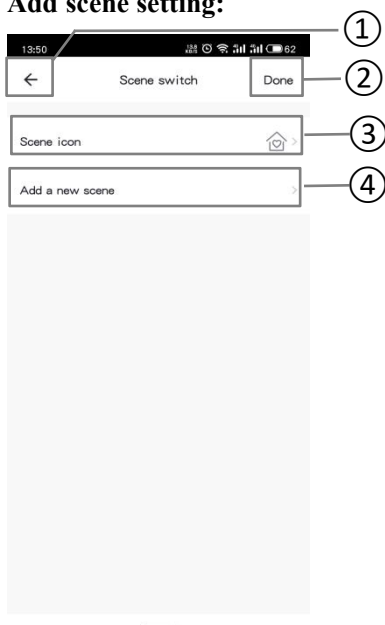

Fig.7.7(2) Scene switch setting

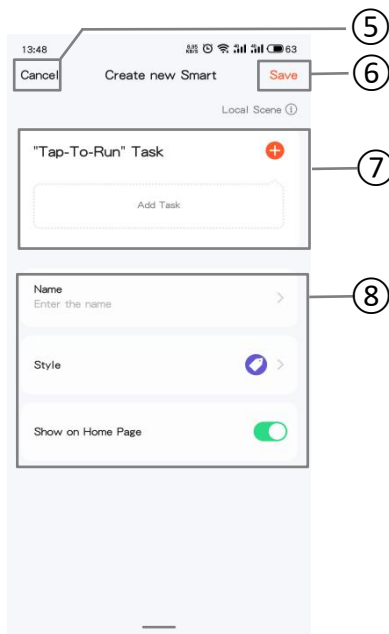

Fig.7.7(3) Create Smart

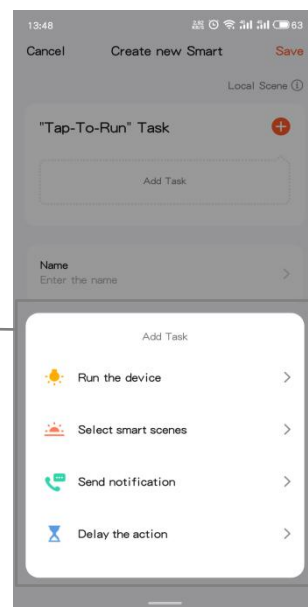

Fig.7.7(4) Add task

- ①⑤Return to the previous interface.
- ②Click to save the setting and return to the previous interface after scene switch setting.
- ③Click to modify scene icon.
- ④Click to go to the interface Create Smart, shown as figure7.7(3).
- ⑥Click to save the setting and return to the previous interface after creating smart.
- ⑦Click plus icon to create“Tap-To-Run” task, the window⑨ is pop up below, you can select required setting, including: all devices, smart scenes, notification and the action delay. Task is shown in figure 7.7(3) after creating successfully.
- ⑧Set the task name, display style, and whether to show on home page.

### Manage scene setting:

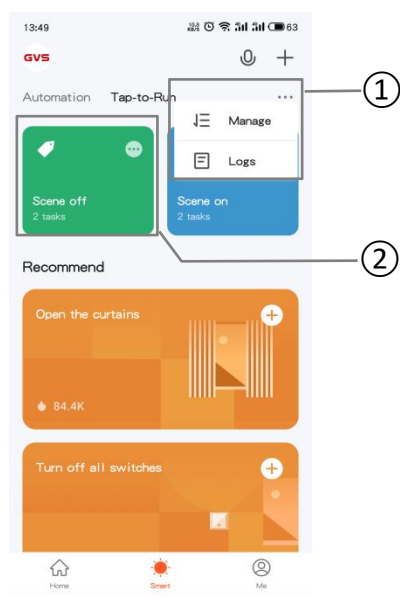

Fig.7.7(5) Smart interface

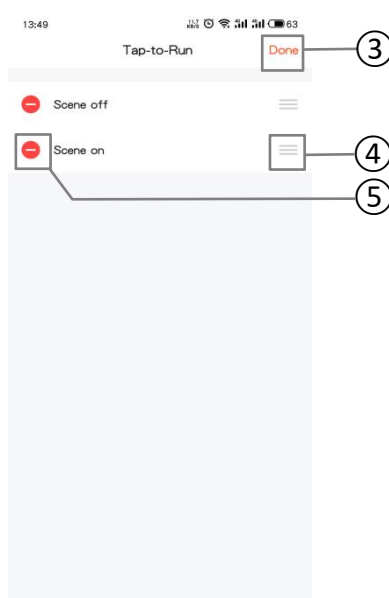

Fig.7.7(6) Manage interface

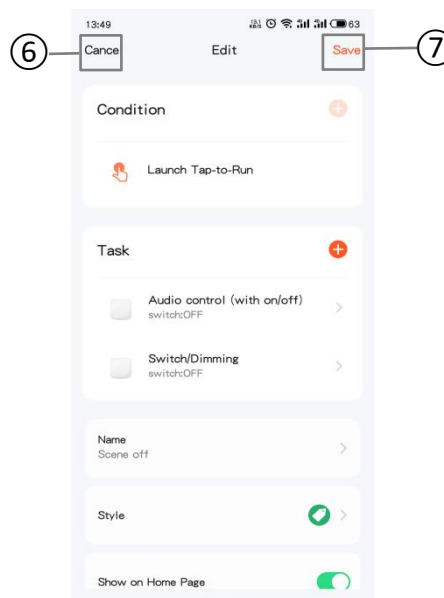

Fig.7.7(7) Edit interface

①Click three-point icon, display drop-down window, you can select **【Manage】** or **【Logs】**, shown as figure 7.7(5). Click **【Manage】** to go to manage interface, shown as figure 7.7(6). Long press icon④ to slide, to adjust the order of scene tasks; click icon⑤ to delete the scene task.

②Click three-point icon, go to the scene edit interface, shown as 7.7(7), operation in the interface: add task, change the task name and display style, whether to show on home page, and delete the scene. Click on the rest of the control to perform the scene immediately.

Operate the edit interface also can be via the single device, such as figure 7.2 (2) device basic setting, to click Tap-to-Run and Automation.



③ Click to save and return to previous interface after task management.

⑥ Click to cancel edit, and return to previous interface.

⑦ Click to save and return to previous interface after editing.

### 7.8. Air condition interface

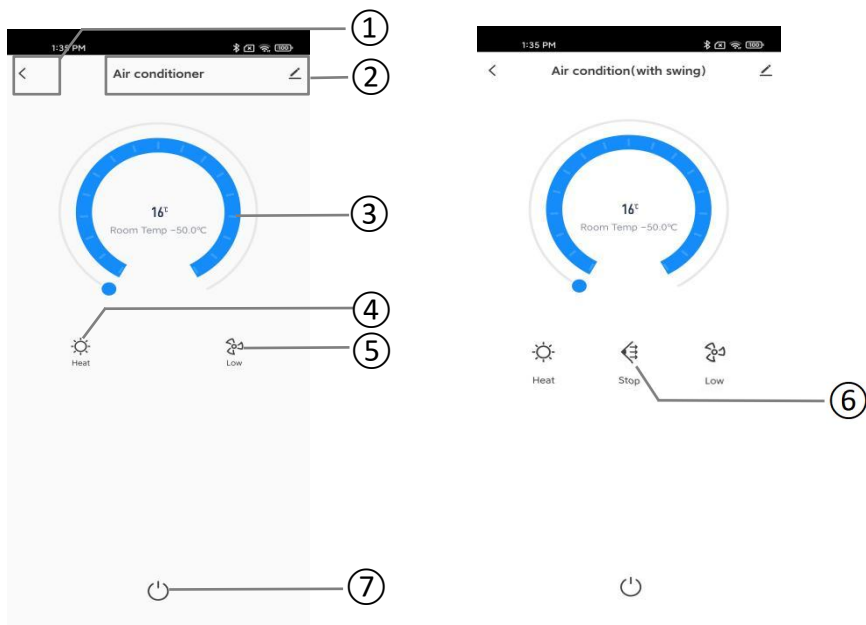







Fig.7.8(1) Air condition interface





Fig.7.8(2) Air condition (with swing) interface



① Return to the previous interface.

② Device name, shown it above the interface. Click icon , you can view, change device settings, and remove devices.

③ Ring slider is used to adjust the setpoint temperature, the performed adjustment step is 1°C. When temperature unit is set to degrees Celsius (°C), adjustment range of setpoint temperature is default as 16 ~ 32°C; Current temperature display according the parameter configuration, you can configure to show detected temperature of internal sensor or external sensor.

④ Click this icon to switch Air condition control mode, update the mode status via the object: Heat , Cool , Dehumidification , Fan , Auto .

⑤ Click this icon to switch fan speed, the current fan speed is cyclically switched in this order--Low speed...AUTO...Low speed: Low speed , Medium speed , High speed , Auto .

⑥ Click this icon switch swing control: swing , stop .

⑦ Air condition switch button, gray indicates status off, bright color indicates status on. When power off, except for the status of power on/off, the other icon status can not be updated via the bus or manually controlled. Click this icon, device sends a telegram of value 1/0 (On/Off) via the object Power on/off.

### 7.9. Room temperature unit interface

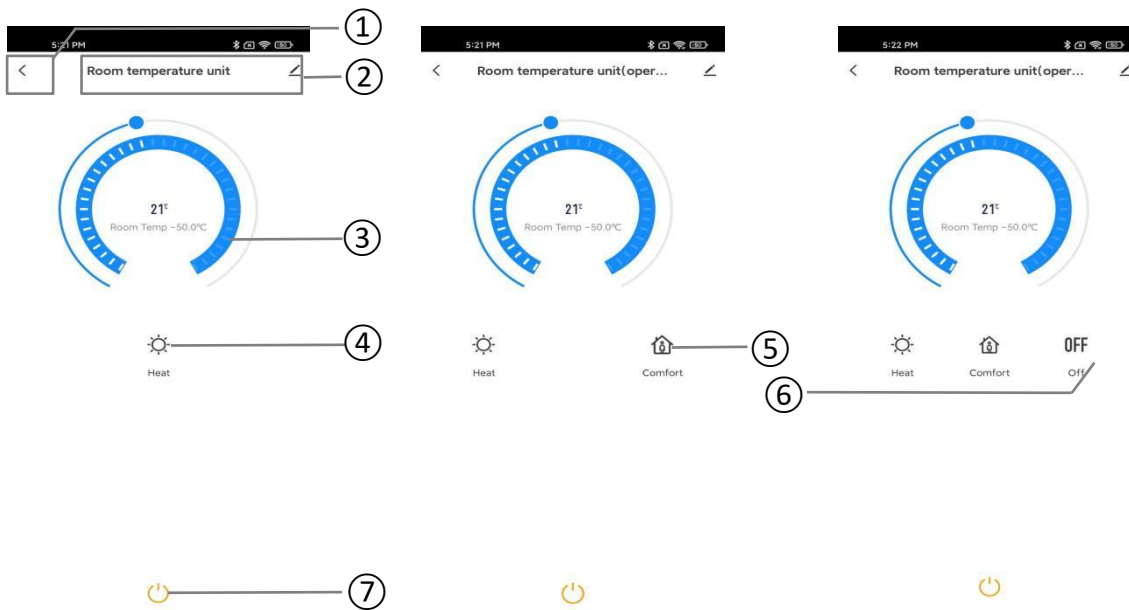



Fig.7.9(1) RTC interface



Fig.7.8(2) RTC (with operation mode ) interface

Fig.7.8(3) RTC (with operation mode&fan speed) interface







① Return to the previous interface.

② Device name, shown it above the interface. Click icon , you can view, change device settings, and remove devices.

③ Ring slider is used to adjust the setpoint temperature, the performed adjustment step is 1°C. When temperature unit is set to degrees Celsius (°C), adjustment range of setpoint temperature is default as 5 ~ 40°C; Current temperature display according the parameter configuration, you can configure to show detected temperature of internal sensor or external sensor.

④ Click this icon to switch control mode, update the mode status via the object: Heating , cooling .

You can switch the mode via touch or telegram when the database sets the RTC control mode to “Heating and Cooling”.

- ⑤ Click this icon to switch operation mode: comfort , standby , economy , protection
- ⑥ Click this icon to switch fan speed, the current fan speed is cyclically switched in this order--Low speed...AUTO...Low speed: Low speed , Medium speed , High speed , Auto .
- ⑦ RTC switch button, gray indicates status off, bright color indicates status on. When power off, except for the status of power on/off, the other icon status can not be updated via the bus or manually controlled. Click this icon, device sends a telegram of value 1/0 (On/Off) via the object Power on/off.

### 7.10. Ventilation system interface

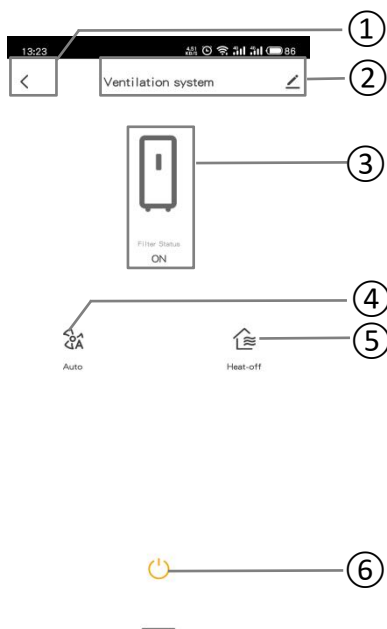







Fig. 7.10 Ventilation system control interface

- ① Return to the previous interface.
- ② Device name, shown it above the interface. Click icon , you can view, change device settings, and remove devices.
- ③ It is used to display the switch status of filter.
- ④ Click this icon to switch fan speed, the current fan speed is cyclically switched in this order--Low speed...AUTO...Low speed: Low speed , Medium speed , High speed , Auto .
- ⑤ Click the icon  to turn on or off heat recovery function.
- ⑥ Ventilation switch button, gray indicates status off, bright color indicates status on. When power off, except for

the status of power on/off, the other icon status can not be updated via the bus or manually controlled. Click this icon, device sends a telegram of value 1/0 (On/Off) via the object Power on/off.

### 7.11. Audio control interface

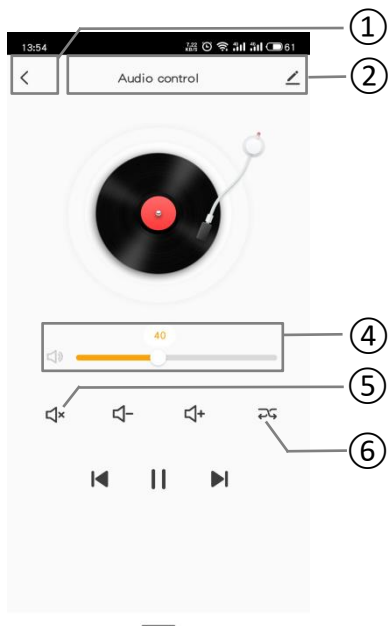

Fig.7.11(1) Audio control interface

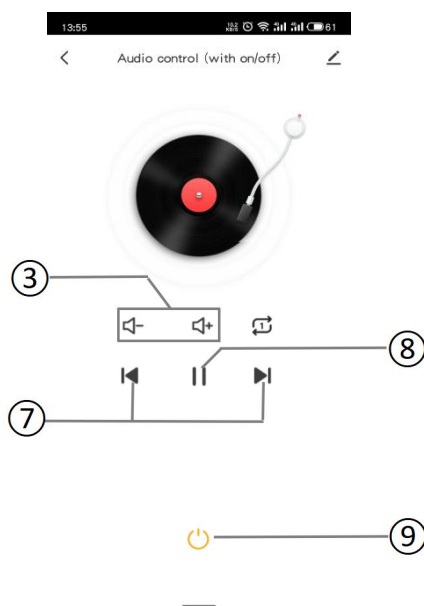





Fig.7.11(2) Audio control (with on/off) interface



①Return to the previous interface.

②Device name, shown it above the interface. Click icon , you can view, change device settings, and remove devices.

③Click the icon to adjust the volume in increasing or decreasing increments.

④Slide the slider to adjust the volume decrease/increase.

⑤Click the icon to mute/exit mute: mute , exit mute .

⑥Click the button to switch the audio play mode. Update the status via the object: single loop , list play , random play .

⑦Click the icon to select previous song or next song.

⑧Click the icon to play or stop music. And update the status via the object.

⑨Audio control switch button, gray indicates status off, bright color indicates status on. When power off, except for the status of power on/off, the other icon status can not be updated via the bus or manually controlled. Click this icon, device sends a telegram of value 1/0 (On/Off) via the object Power on/off.

## 7.12. Sensor interface

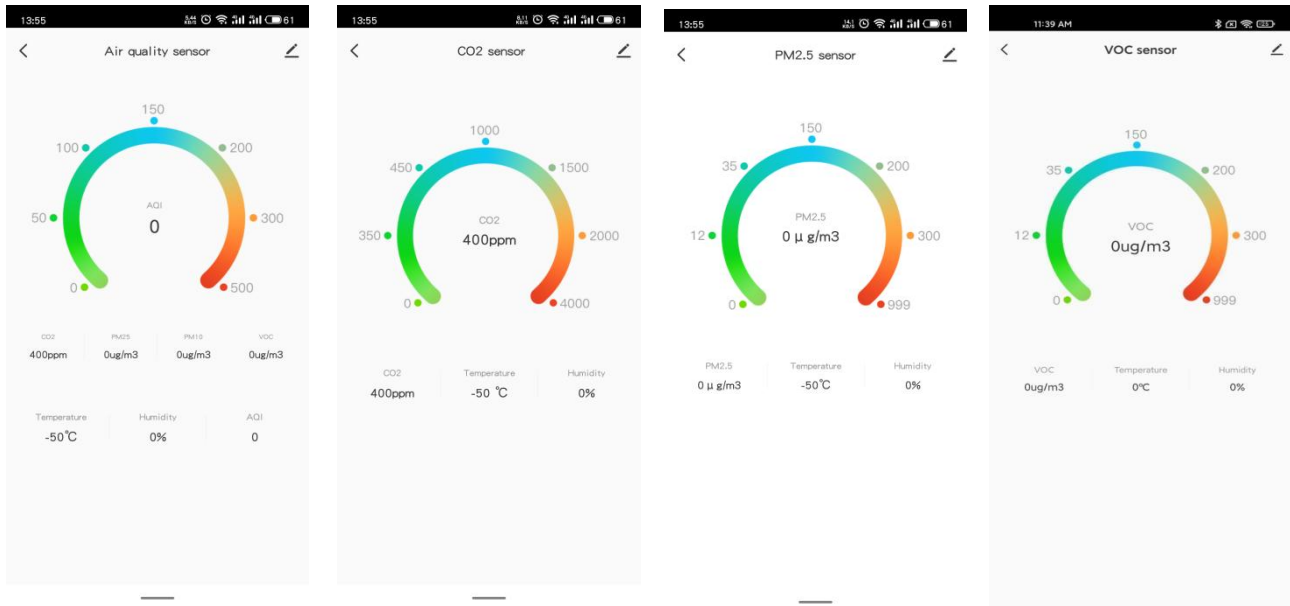

Air quality sensor interface

CO2 sensor interface

PM2.5 sensor interface

VOC sensor interface

Air quality sensor displays 7 reference values, independently is: CO2, PM2.5, PM10, VOC, Temperature, Humidity, AQI. What displays can be configured through the database. The CO2, PM2.5 and VOC have separate detectors, and all can show the internal temperature and humidity on the interface.

The ring on the interface and the reference values of corresponding devices. The update of the display value can be achieved by rewriting the object via the bus.

Detection range of AQI: 0..500

Detection range of CO2: 0..4000ppm

Detection range of PM2.5: 0..999ug/m<sup>3</sup>

Detection range of VOC: 0..999ug/m<sup>3</sup>

Detection range of temperature: -50...90°C

Detection range of humidity: 0..100%

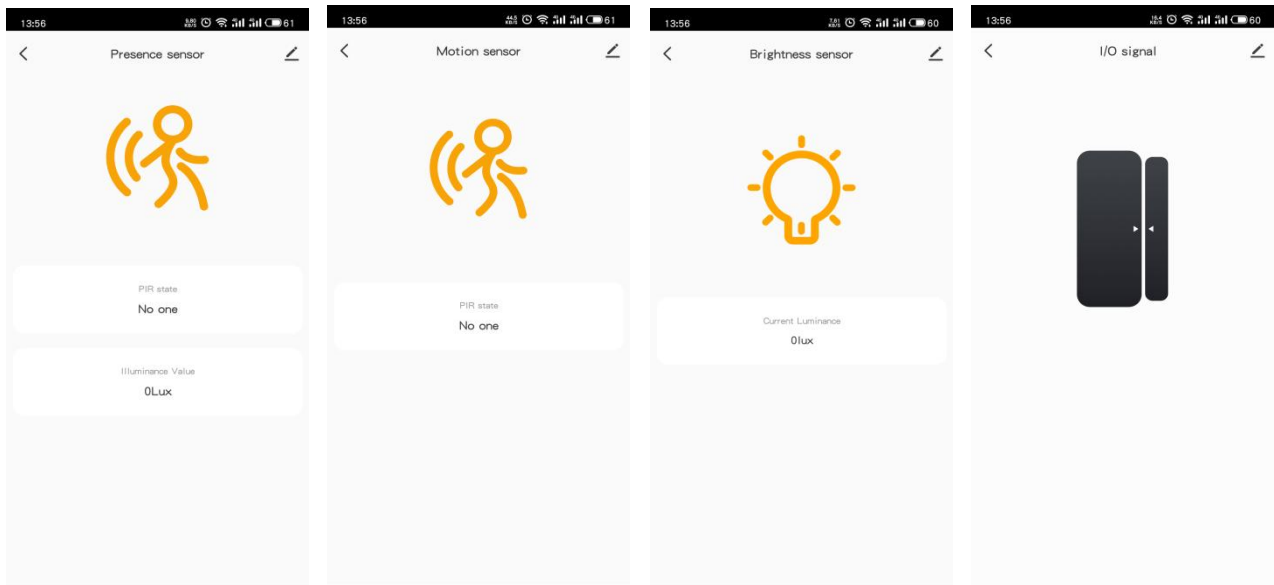

Presence sensor interface

Motion sensor interface

Brightness sensor interface

I/O signal interface

Presence sensor can detect PIR state, and illuminance, detection range: 0...65535lux

Motion sensor can detect PIR state.

Brightness sensor can detect the illuminance, detection range: 0...65535lux

I/O signal can detect the device switch status.

### 7.13. Current/Energy metering interface

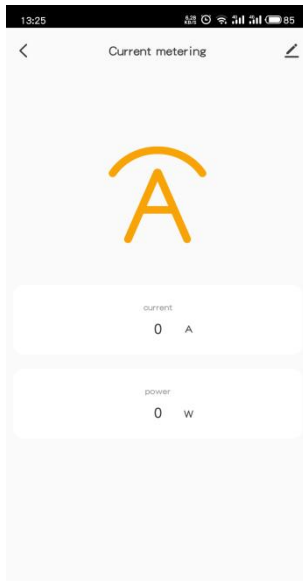

Current metering

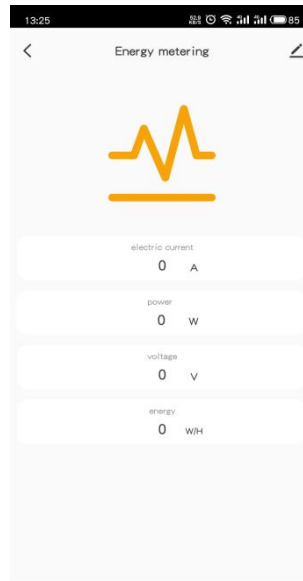

Energy metering

Current metering detects the current and power, and display the changing status in real-time, the values unit and resolution can be rewrite via the object on the bus.

Energy metering detects the current, power, voltage and energy, and display the changing status in real-time, the values unit and resolution can be rewrite via the object on the bus.



### 7.14. Voice control command

This chapter mainly list the voice control commands for Tuya Smart APP. You can find the command of ETS function to voice control. **Note: Currently , only the devices listed below are supported.**

ETS functions	Voice control command Note: the specific content in <> is determined by the name edited on the APP. Only support English. The same as below.	
	Amazon Alexa	Google Assistant
Switch	Alexa, turn on <device name> Alexa, turn off <device name>	OK Google, turn on <device name> OK Google, turn off <device name>
Switch/Dimming	<b>Switch:</b> Alexa, turn on <device name> Alexa, turn off <device name> <b>Dimming:</b> Alexa, set the bedroom light to fifty percent Alexa, brighten <device name> Alexa, dim <device name>	<b>Switch:</b> OK Google, turn on <device name> OK Google, turn off <device name> <b>Dimming:</b> OK Google, what is the brightness level of <device name>? OK Google, adjust <device name> to 65% brightness OK Google, brighten the <device name> OK Google, dim the <device name>
RGB Dimming	<b>Switch:</b> Alexa, turn on <device name> Alexa, turn off <device name>	<b>Switch:</b> OK Google, turn on <device name> OK Google, turn off <device name>
RGBW Dimming	<b>Switch:</b> Alexa, turn on <device name> Alexa, turn off <device name>	<b>Switch:</b> OK Google, turn on <device name> OK Google, turn off <device name>
Color Temperature	<b>Switch:</b> Alexa, turn on <device name> Alexa, turn off <device name> <b>Dimming:</b> Alexa, set the bedroom light to fifty percent Alexa, brighten <device name> Alexa, dim <device name>	<b>Switch:</b> OK Google, turn on <device name> OK Google, turn off <device name>

ETS functions	Voice control command	
	Amazon Alexa	Google Assistant
Color Temperature	<p><b>Color temperature:</b></p> <p>Alexa, make the living room lights warmer</p> <p>Alexa, set the dining room lights cooler</p> <p>Alexa, set the dining room softer</p> <p>Alexa, make the living room light whiter</p> <p>Alexa, make the living room light warm white</p> <p>Alexa, set the kitchen to daylight</p>	<p><b>Dimming:</b></p> <p>OK Google, what is the brightness level of &lt;device name&gt;?</p> <p>OK Google, adjust &lt;device name&gt; to 65% brightness</p> <p>OK Google, brighten the &lt;device name&gt;</p> <p>OK Google, dim the &lt;device name&gt;</p> <p><b>Color temperature:</b></p> <p>OK Google, set the &lt;device name&gt; to cool white</p>
Curtain step/move	<p><b>Curtain switch:</b></p> <p>Alexa, turn on &lt;device name&gt;</p> <p>Alexa, turn off &lt;device name&gt;</p>	<p><b>Curtain switch:</b></p> <p>OK Google, turn on &lt;device name&gt;</p> <p>OK Google, turn off &lt;device name&gt;</p> <p><b>Work status:</b></p> <p>OK Google, pause &lt;device name&gt;</p> <p>OK Google, resume &lt;device name&gt;</p>
Roller blind step/move	<p><b>Curtain switch:</b></p> <p>Alexa, turn on &lt;device name&gt;</p> <p>Alexa, turn off &lt;device name&gt;</p>	<p><b>Curtain switch:</b></p> <p>OK Google, turn on &lt;device name&gt;</p> <p>OK Google, turn off &lt;device name&gt;</p> <p><b>Work status:</b></p> <p>OK Google, pause &lt;device name&gt;</p> <p>OK Google, resume &lt;device name&gt;</p>
Curtain position	<p><b>Curtain switch:</b></p> <p>Alexa, turn on &lt;device name&gt;</p> <p>Alexa, turn off &lt;device name&gt;</p> <p><b>Percentage position:</b></p> <p>Alexa, set the &lt;device name&gt; to thirty percent</p> <p>Alexa, increase &lt;device name&gt; by ten percent</p> <p>Alexa, decrease &lt;device name&gt; by twenty percent</p>	<p><b>Curtain switch:</b></p> <p>OK Google, turn on &lt;device name&gt;</p> <p>OK Google, turn off &lt;device name&gt;</p> <p><b>Work status:</b></p> <p>OK Google, pause &lt;device name&gt;</p> <p>OK Google, resume &lt;device name&gt;</p> <p><b>Percentage position:</b></p> <p>OK Google, open &lt;device name&gt;</p> <p>OK Google, close &lt;device name&gt;</p>

ETS functions	Voice control command	
	Amazon Alexa	Google Assistant
Roller blind position	<p><b>Curtain switch:</b> Alexa, turn on &lt;device name&gt; Alexa, turn off &lt;device name&gt;</p> <p><b>Percentage position:</b> Alexa, set the &lt;device name&gt; to thirty percent Alexa, increase &lt;device name&gt; by ten percent Alexa, decrease &lt;device name&gt; by twenty percent</p>	<p><b>Curtain switch:</b> OK Google, turn on &lt;device name&gt; OK Google, turn off &lt;device name&gt;</p> <p><b>Work status:</b> OK Google, pause &lt;device name&gt; OK Google, resume &lt;device name&gt;</p> <p><b>Percentage position:</b> OK Google, open &lt;device name&gt; OK Google, close &lt;device name&gt;</p>
Venetian blind position and slat	<p><b>Curtain switch:</b> Alexa, turn on &lt;device name&gt; Alexa, turn off &lt;device name&gt;</p> <p><b>Work status:</b> Alexa, pause device Alexa, resume device</p>	<p><b>Curtain switch:</b> OK Google, turn on &lt;device name&gt; OK Google, turn off &lt;device name&gt;</p> <p><b>Work status:</b> OK Google, start the washing machine OK Google, stop &lt;device name&gt;</p>
Value sender /Scene switch	<p>Alexa, turn on &lt;device name&gt; Alexa, turn off &lt;device name&gt;</p>	<p>OK Google, turn on &lt;device name&gt; OK Google, turn off &lt;device name&gt;</p>
Air conditioner	<p><b>Power:</b> Alexa, turn on &lt;device name&gt; Alexa, turn off &lt;device name&gt;</p> <p><b>Control mode:</b> Alexa, set the &lt;mode name&gt; on the &lt;device name&gt; to &lt;mode value&gt;</p> <p><b>Temperature:</b> Alexa, make it warmer in here Alexa, make it cooler in here Alexa, what is the target temperature of the &lt;device name&gt;? Alexa, set &lt;device name&gt; to twenty Alexa, set &lt;device name&gt; to N</p> <p><b>Check actual temperature:</b> Alexa, what is the temperature of &lt;device name&gt;</p> <p><b>Fan speed level:</b> Alexa, set the fan speed on the &lt;device name&gt; to &lt;mode value&gt;</p>	<p><b>Power:</b> OK Google, turn on &lt;device name&gt; OK Google, turn off &lt;device name&gt;</p> <p><b>Control mode:</b> OK Google, set &lt;device name&gt; to &lt;mode value&gt;</p> <p><b>Temperature:</b> OK Google, set the &lt;device name&gt; to 350 degrees</p> <p><b>Check actual temperature:</b> OK Google, what is the current device temperature?</p> <p><b>Fan speed level:</b> OK Google, set the &lt;device name&gt; to low OK Google, set the &lt;device name&gt; to high</p>

ETS functions	Voice control command	
	Amazon Alexa	Google Assistant
Air condition (with swing)	<p><b>Power:</b> Alexa, turn on &lt;device name&gt; Alexa, turn off &lt;device name&gt;</p> <p><b>Control mode:</b> Alexa, set the &lt;mode name&gt; on the &lt;device name&gt; to &lt;mode value&gt;</p> <p><b>Temperature:</b> Alexa, make it warmer in here Alexa, make it cooler in here Alexa, what is the target temperature of the &lt;device name&gt;? Alexa, set &lt;device name&gt; to twenty Alexa, set &lt;device name&gt; to N</p> <p><b>Check actual temperature:</b> Alexa, what is the temperature of &lt;device name&gt;</p> <p><b>Fan speed level:</b> Alexa, set the fan speed on the &lt;device name&gt; to &lt;mode value&gt;</p> <p><b>Swing:</b> Alexa, turn on horizontal swing on &lt;device name&gt; Alexa, turn off horizontal swing on &lt;device name&gt;</p>	<p><b>Power:</b> OK Google, turn on &lt;device name&gt; OK Google, turn off &lt;device name&gt;</p> <p><b>Control mode:</b> OK Google, set &lt;device name&gt; to &lt;mode value&gt;</p> <p><b>Temperature:</b> OK Google, set the &lt;device name&gt; to 350 degrees</p> <p><b>Check actual temperature:</b> OK Google, what is the current device temperature?</p> <p><b>Fan speed level:</b> OK Google, set the &lt;device name&gt; to low OK Google, set the &lt;device name&gt; to high</p> <p><b>Swing:</b> Turn on/off &lt;device name&gt;</p>

ETS functions	Voice control command	
	Amazon Alexa	Google Assistant
Room temperature unit	<p><b>Power:</b> Alexa, turn on &lt;device name&gt; Alexa, turn off &lt;device name&gt;</p> <p><b>Control mode:</b> Alexa, set the &lt;mode name&gt; on the &lt;device name&gt; to &lt;mode name&gt;</p> <p><b>Temperature:</b> Alexa, make it warmer in here Alexa, make it cooler in here Alexa, what is the target temperature of the &lt;device name&gt;? Alexa, set &lt;device name&gt; to twenty Alexa, set &lt;device name&gt; to N</p> <p><b>Check actual temperature:</b> Alexa, what is the temperature of &lt;device name&gt;</p>	<p><b>Power:</b> OK Google, turn on &lt;device name&gt; OK Google, turn off &lt;device name&gt;</p> <p><b>Control mode:</b> OK Google, set &lt;device name&gt; to &lt;mode value&gt;</p> <p><b>Temperature:</b> OK Google, set the &lt;device name&gt; to 350 degrees</p> <p><b>Check actual temperature:</b> OK Google, what is the current device temperature?</p>
Room temperature unit (with operation mode)	<p><b>Power:</b> Alexa, turn on &lt;device name&gt; Alexa, turn off &lt;device name&gt;</p> <p><b>Operation/Control mode:</b> Alexa, set the &lt;mode name&gt; on the &lt;device name&gt; to &lt;mode name&gt;</p> <p><b>Temperature:</b> Alexa, make it warmer in here Alexa, make it cooler in here Alexa, what is the target temperature of the &lt;device name&gt;? Alexa, set &lt;device name&gt; to twenty Alexa, set &lt;device name&gt; to N</p> <p><b>Check actual temperature:</b> Alexa, what is the temperature of &lt;device name&gt;</p>	<p><b>Power:</b> OK Google, turn on &lt;device name&gt; OK Google, turn off &lt;device name&gt;</p> <p><b>Operation/Control mode:</b> OK Google, set &lt;device name&gt; to &lt;mode value&gt;</p> <p><b>Temperature:</b> OK Google, set the &lt;device name&gt; to 350 degrees</p> <p><b>Check actual temperature:</b> OK Google, what is the current device temperature?</p>

ETS functions	Voice control command	
	Amazon Alexa	Google Assistant
Room temperature unit (with operation mode & fan speed)	<p><b>Power:</b></p> <p>Alexa, turn on &lt;device name&gt;</p> <p>Alexa, turn off &lt;device name&gt;</p> <p><b>Operation/Control mode:</b></p> <p>Alexa, set the &lt;mode name&gt; on the &lt;device name&gt; to &lt;mode name&gt;</p> <p><b>Temperature:</b></p> <p>Alexa, make it warmer in here</p> <p>Alexa, make it cooler in here</p> <p>Alexa, what is the target temperature of the &lt;device name&gt;?</p> <p>Alexa, set &lt;device name&gt; to twenty</p> <p>Alexa, set &lt;device name&gt; to N</p> <p><b>Check actual temperature:</b></p> <p>Alexa, what is the temperature of &lt;device name&gt;</p> <p><b>Fan speed level:</b></p> <p>Alexa, set the fan speed on the &lt;device name&gt; to &lt;mode value&gt;</p>	<p><b>Power:</b></p> <p>OK Google, turn on &lt;device name&gt;</p> <p>OK Google, turn off &lt;device name&gt;</p> <p><b>Operation/Control mode:</b></p> <p>OK Google, set &lt;device name&gt; to &lt;mode value&gt;</p> <p><b>Temperature:</b></p> <p>OK Google, set the &lt;device name&gt; to 350 degrees</p> <p><b>Check actual temperature:</b></p> <p>OK Google, what is the current device temperature?</p> <p><b>Fan speed level:</b></p> <p>OK Google, set the &lt;device name&gt; to low</p> <p>OK Google, set the &lt;device name&gt; to high</p>
Ventilation system	<p><b>Power:</b></p> <p>Alexa, turn on &lt;device name&gt;</p> <p>Alexa, turn off &lt;device name&gt;</p> <p><b>Fan speed level:</b></p> <p>Alexa, set the fan speed on the &lt;device name&gt; to &lt;mode value&gt;</p>	

ETS functions	Voice control command	
	Amazon Alexa	Google Assistant
Audio control	<p><b>Volume:</b>                      Alexa, set the volume of the speakers to fifty                      Alexa, turn the volume down on the stereo by twenty                      Alexa, turn the volume down on Living Room TV                      Alexa, mute speakers                      Alexa, unmute speakers</p> <p><b>Track change:</b>                      Alexa, previous on device                      Alexa, next song/video/photo on device</p>	<p><b>Volume:</b>                      OK Google, make the &lt;device name&gt; a little quieter                      OK Google, mute &lt;device name&gt;</p> <p><b>Mute mode:</b>                      Turn on &lt;device name&gt;                      Turn off &lt;device name&gt;</p>
Audio control(with on/off)	<p><b>Power:</b>                      Alexa, open &lt;device name&gt;                      Alexa, close &lt;device name&gt;</p> <p><b>Play/pause:</b>                      Alexa, pause device                      Alexa, resume device</p> <p><b>Track change:</b>                      Alexa, previous on device                      Alexa, next song/video/photo on device</p>	<p><b>Power:</b>                      OK Google, turn on &lt;device name&gt;                      OK Google, turn off &lt;device name&gt;</p>
Air quality sensor	<p><b>Temperature check:</b>                      Alexa, what is the temperature of &lt;device name&gt;</p> <p><b>Humidity check:</b>                      Alexa, what is the bedroom humidity?</p> <p><b>CO2 check:</b>                      Alexa, what's the &lt;device name&gt; &lt;range name&gt;?</p>	<p><b>Temperature check:</b>                      OK Google, what is the current device temperature?</p> <p><b>Humidity check:</b>                      OK Google, what humidity does my humidifier show?</p> <p><b>CO2 check:</b>                      OK Google, is the &lt;sensor name&gt; detecting carbon dioxide                      OK Google, Is carbon dioxide detected                      OK Google, do you detect carbon dioxide in the room</p>



ETS functions	Voice control command	
	Amazon Alexa	Google Assistant
CO2 sensor	Alexa, what's the <device name> <range name>?	OK Google, is the <sensor name> detecting carbon dioxide OK Google, Is carbon dioxide detected OK Google, do you detect carbon dioxide in the room
Presence sensor	Alexa, what's the <device name> <range name>?	
Brightness sensor	Alexa, what's the <device name> <range name>?	



## Chapter 8 Tuya Zigbee Gateway Management System

Tuya Zigbee Gateway Management System only apply to **KNX Gateway for Tuya ZigBee, Premium**, use web to configure and manage the links between ZigBee devices and KNX system. Before enter to the system, please ensure that the gateway is connected to LAN correctly, then configure IP address and Zigbee channel via ETS. This management system only makes secondary configuration for the devices.

Ensure the computer and mobile phone is in the same LAN, then enter IP address (this IP address belongs to **KNX Gateway for Tuya ZigBee, Premium**, you can check the gateway information on the APP to get it) in the browser to enter the management system. The system operation and ZigBee device linking will be explained in the following chapters.

### 8.1. Gateway information



### Tuya Zigbee Gateway Management System

Gateway Information	Overview					
ZigBee device list	IP	MAC	Default GW.	License account	License password	FW.version
ZigBee function list	192.168.1.10	1c:87:76:90:f1:28	192.168.1.1	sskj20036033ca0ed822	uwCJLaArOkUUTWib7ck9FXTS4d4HMcv	01.00.17

© 2021 GVS

In the system, you can see the based information of the gateway, including the IP address, MAC address, default gateway address, Tuya license account and password, and firmware version.

Click the upper right corner of the webpage to switch languages :  Chinese;  English.

## 8.2. ZigBee device list

### Tuya Zigbee Gateway Management System

Click “ZigBee device list”, you can view the information of ZigBee devices that are linked/to be linked. As follow:

Virtual ID	Assigned automatically by the system.
Name	Display ZigBee device name. User can customize the name, if it is not defined, it will be empty.
MAC	MAC address of the device.
Status	Online/Offline
KNX Name	The name configured in ETS.
ZigBee Channel	Display the bound ZigBee channel number, corresponding to the ETS setting, number is 1~32.
Operation setting	DVC: use to link the ZigBee device to corresponding ZigBee channel. FUN: use to link the ZigBee device to corresponding ZigBee function. EDIT: use to change ZigBee device name. DEL: use to delete the linking information of ZigBee device.

**Note: If the device is already linked, the DVC button is not operable. If the device is not linked, FUN/DEL buttons are not operable.**

### 8.3. ZigBee function list

#### Tuya Zigbee Gateway Management System



The screenshot shows a web interface with a sidebar on the left containing menu items: Gateway Information, ZigBee device list, and ZigBee function list (which is highlighted). The main content area is titled 'Overview' and contains a table with the following data:

Device	MAC	Fun.ID	Data mode	Status value	Device type	Linking
SwitchDimming	bc33acfffe452684	1	Status/Control	0	Switch/Dimming	Switch
SwitchDimming	bc33acfffe452684	2	Status/Control	0	Switch/Dimming	Brightness

Below the table, it says 'Showing 1 to 2 of 2 entries' and there are navigation buttons: First, Previous, 1 (selected), Next, Last.

Click “ZigBee function list”, you can view the information of ZigBee functions that are already linked. The detail operation you can refer to chapter 8.4.

**Device** Display device name, you can change it in “Operation setting” of “ZigBee device list”.

**MAC** Display MAC address of the device.

**Fun.ID** Display the function ID number that is linked.

**Data mode** Display the data transmission mode of the device. There are 3 modes:  
 Status: ZigBee device only uploads the current status value to the management system or KNX;

Control: ZigBee device only receives the control command from other terminals (such as APP and KNX).

Status/Control: ZigBee device not only can upload the current status value, but also can receive the control command.

**Status value** Display the status value fed back from ZigBee device to KNX bus.

**Note: data with decimal point is displayed as an integer, for example, the value is 26.7, and the system displays 267; The value is 77%, and the system displays 766.**

**Device type** Display the ZigBee device type, according to the linked channel and function.

**Linking** Display the linked ZigBee function, you can change it in “Operation setting” of “ZigBee device list”.

### 8.4. Linking the ZigBee device

Operation of linking the ZigBee device is as follow:

(1) Firstly, configure ZigBee channel in ETS, including name, MAC address, device type and etc.. Then download to the gateway, add the gateway and sub devices to Tuya Smart APP according to chapter 7.1. Enter the gateway IP address in the browser into Tuya Zigbee Gateway Management System, it displays ZigBee devices that are linked/to be linked, as shown as follow:

Virtual ID	Name	MAC	Status	KNX Name	ZigBee Channel	Operation setting
1	ColorTemp.	a4c138e586e7d8b1	online	ColorTemp.	19	DVC FUN EDIT DEL
4	Airbox	a4c138b1f7b1e88d	online	VOC CO2 Formaldehyde DPT9.	1	DVC FUN EDIT DEL
6	Curtain 1	2c1165fffe69170c	online	Curtain 1	21	DVC FUN EDIT DEL
7		804b50fffeb1e516	online	Temp.&Humidity sensor	3	DVC FUN EDIT DEL
8		000d6ffffed1fc50	online	I/O Switch DPT 1.001	9	DVC FUN EDIT DEL
10		00124b0023b440d5	online			DVC FUN EDIT DEL
11	SwitchDimming	bc33acfffe452684	online	SwitchDimming	22	DVC FUN EDIT DEL

(2) Link KNX function. View the MAC address on the APP firstly, each ZigBee device has corresponding unique MAC address. Click the DVC button in “ZigBee device list” page, pop-up the setting page, then click on the “Function selection” drop-down box, select the corresponding function to link, and then display the KNX name, which is configured in ETS and can not change. “ZigBee Device Name” is customized by the user. Click “Submit” after completion.

Please select KNX function ×

---

**MAC:**  
bc33acfffe452684

**KNX Name:**  
Function selection

**ZigBee Device Name:**

Please select KNX function ×

---

**MAC:**  
bc33acfffe452684

**KNX Name:**  
SwitchDmming

**ZigBee Device Name:**  
SwitchDmming

(3) After completing the last step, auto return to “ZigBee device list” page, when the column of the “ZigBee Channel” has number displayed, the device is linked to the ZigBee channel. At this time, the DVC button can no longer be operated.

11	SwitchDimming	bc33acfffe452684	online	SwitchDimming	22	DVC FUN EDIT DEL
----	---------------	------------------	--------	---------------	----	------------------

**Note:**

The same ZigBee channel can not be linked to multiple ZigBee devices, or it will pop-up the prompt to change channel.

If preset MAC address in ETS, as shown as follow, the gateway will assign the channel linking automatically to the ZigBee device with this MAC address. There is no need to do steps (2) and (3) on the system and DVC button is not operable at this time, it only need to operate step (4) to link the ZigBee function.

Description (max 24char.)	SwitchDimming
Preset Mac address of zigbee device	bc33acfffe452684
<i>i</i> 8 hexadecimal data format, which can get from the property of ZigBee device on App	
Device type	Switch/Dimming

MAC address can be obtained from Device information in Tuya Smart APP. View the device MAC address as follow:

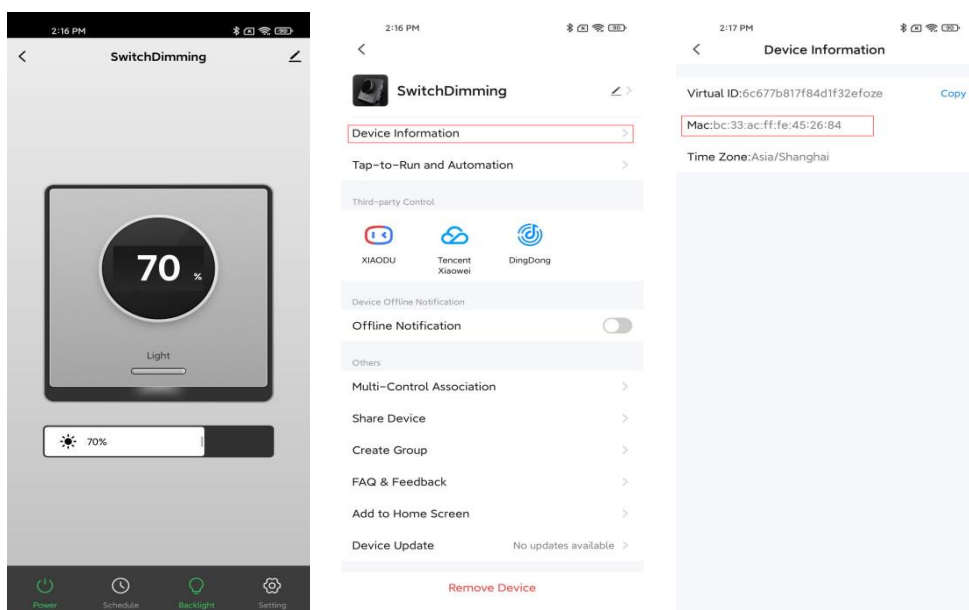

If not preset MAC address, system displays the ZigBee devices scanned by the gateway , follow the steps to link the ZigBee channel and function.

(4)Link the ZigBee function. When the device is linked the ZigBee channel, click the FUN button in the “ZigBee device list” page, pop-up the setting page, setting as follow:

ZigBee function list ×

Fun.ID	Type	Data mode	Status value	Linking	Operation setting
1	bool	Status/Control	1	Swich	--Function selection-- ▾
2	value	Status/Control	766	Dimming	--Function selection-- ▾
3	value	Status/Control	0		--Function selection-- ▾
4	enum	Status/Control	0		--Function selection-- ▾
5	value	Status/Control	0		--Function selection-- ▾
13	enum	Status/Control	0		--Function selection-- ▾
101	bool	Status/Control	0		--Function selection-- ▾

Showing 1 to 7 of 7 entries First Previous **1** Next Last

**Fun.ID** Display the ZigBee function number.

**Type** Display the function type (bool, value, enumeration, character and etc.).

**Data mode** Display the data mode of the function , there are 3 modes: Status; Control; Status/Control.

**Status value** Display status value of the corrsponding function.

**Note: data with decimal point is displayed as an integer, for example, the value is 77%, and the system displays 766.**

**Linking** Display the linked ZigBee function.

**Operation setting** Operate ZigBee device function on the APP, if the status value in the setting page changes and is similar to the status information on the APP (If there are no changes, please refresh the system), then click on the “Function selection” drop-down box, select the corresponding function to link.

e.g: The dimming device with the MAC address bc33acfffe452684 is linked to the ZigBee channel on the system, then operate the device on the APP, Function ID1=1 and ID2=766 is corresponding to dimmer ON and brightness value 77% on the APP, as shown as above figure. Click the “Function selection” drop-down box according to the status value and select the corresponding function to link.

ZigBee function linking for other devices can be analogized.



(5)After completing the function linking, display the configured ZigBee device on the “ZigBee function list” page.

Device	MAC	Fun.ID	Data mode	Status value	Device type	Linking
ColorTemp.	a4c138e586e7d8b1	1	Status/Control	1	Color Temperature	Switch
ColorTemp.	a4c138e586e7d8b1	3	Status/Control	348	Color Temperature	Brightness
ColorTemp.	a4c138e586e7d8b1	4	Status/Control	235	Color Temperature	Color Temp.
Airbox	a4c138b1f7b1e88d	2	Status	364	Air Quality Sensor	CO2
Airbox	a4c138b1f7b1e88d	18	Status	262	Air Quality Sensor	Temperature
Airbox	a4c138b1f7b1e88d	19	Status	520	Air Quality Sensor	Humanity
Airbox	a4c138b1f7b1e88d	21	Status	0	Air Quality Sensor	VOC
Airbox	a4c138b1f7b1e88d	22	Status	0	Air Quality Sensor	Formaldehyde
Curtain 1	2c1165ffffe69170c	1	Status/Control	1	curtain1	Step/move
	804b50fffeb1e516	101	Status/Control	0	Temperature and humidity sensor	Humanity

(6)After completing the above steps, you can control ZigBee devices via KNX or Tuya Smart APP, and also can upload the current status of the ZigBee device to the cloud or KNX.

(7)Edit the device name. Click EDIT button on the “ZigBee device list” page, pop-up the setting page, enter the custom name in “Device Name” input box, click “OK”, then the device name can be replaced.

Name setting ×

---

**MAC:**  
bc33acfffe452684

**Device Name:**  
SwitchDimming

OK

(8)Remove the device linking. Click DEL button on the “ZigBee device list” page, pop-up the page to select whether to delete, click “OK”, then clean the linking information of the ZigBee device. As shown as follow.

192.168.1.10

Delete the record with id=11?

OK
Cancel

Virtual ID	Name	MAC	Status	KNX Name	ZigBee Channel	Operation setting
1	ColorTemp.	a4c138e586e7d8b1	online	ColorTemp.	19	<a href="#">DVC</a> <a href="#">FUN</a> <a href="#">EDIT</a> <a href="#">DEL</a>
4	Airbox	a4c138b1f7b1e88d	online	VOC CO2 Formaldehyde DPT9.	1	<a href="#">DVC</a> <a href="#">FUN</a> <a href="#">EDIT</a> <a href="#">DEL</a>
6	Curtain 1	2c1165fffe69170c	online	Curtain 1	21	<a href="#">DVC</a> <a href="#">FUN</a> <a href="#">EDIT</a> <a href="#">DEL</a>
7		804b50fffeb1e516	online	Temp.&Humidity sensor	3	<a href="#">DVC</a> <a href="#">FUN</a> <a href="#">EDIT</a> <a href="#">DEL</a>
8		000d6ffffed1fc50	online	I/O Switch DPT 1.001	9	<a href="#">DVC</a> <a href="#">FUN</a> <a href="#">EDIT</a> <a href="#">DEL</a>
10		00124b0023b440d5	online			<a href="#">DVC</a> <a href="#">FUN</a> <a href="#">EDIT</a> <a href="#">DEL</a>
12	SwitchDimming	bc33acfffe452684	online	SwitchDimming	22	<a href="#">DVC</a> <a href="#">FUN</a> <a href="#">EDIT</a> <a href="#">DEL</a>

**Note:** After deletion, the item will be automatically arranged at the last of the list, and the FUN / DEL button are inoperable at this time.

## Chapter 9 OTA for KNX Gateway for Tuya ZigBee

KNX Gateway for Tuya ZigBee upgrades new firmware remotely (OTA) via Tuya Smart APP.

Operation as follow:

(1) Enter the gateway home page, if there is a new device firmware released, the page will pop up the update reminder. If the new firmware is released but you do not receive the update, please contact GVS technical support.

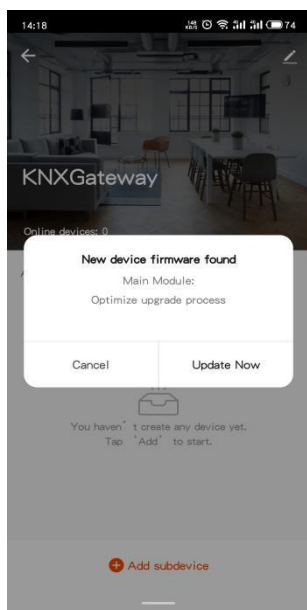

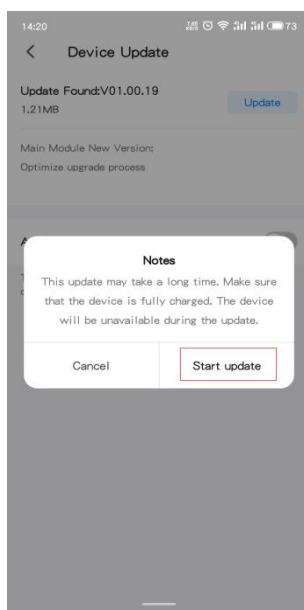
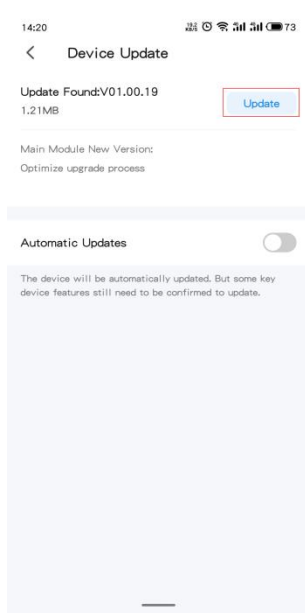

(2) Click “Update Now” to enter the Device Update page, which notes the Main Module New Version and the update content. Then click “Update”, pup up the update reminder, please ensure that the power supply for gateway is normal during updating, and it will be unavailable during the update, then click “Start update”.

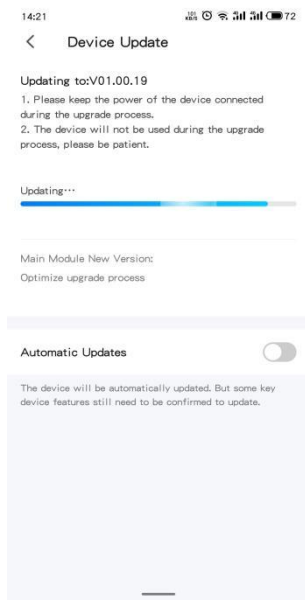

User can set the gateway to update automatically. But some key device features still need to be confirmed to update.

(3)After entering the update status, the page is shown in the figure below, please do not do anything at this time. Wait about 1 minute, the APP prompt update success.



(4)Check the device update. Click the icon  in the gateway home page to enter management page, click “Device Update”, if upgraded, it will show “No updates available” and Main Module version; if there is a new update, you can follow these steps above to update.

**If you have any questions about the latest version, please contact GVS technical support.**

